



YOUR
OWN
STYLE
ACCESSORIES

 **inda**[®]
bathroom interiors

INDEX

Your own style.

HISTORY	2	GRAB-BARS	148
TOTAL LIVING	4	STOOLS	152
YOUR OWN COLOR	6	BASKETS	154
		STANDS	162
MY ART/MY LOVE/MY WAY/MY LIKE	8	TABLETOP SERIES	166
MY ART	12		
MY LOVE	16	FINISHES	170
MY WAY	22	SYMBOL KEY	175
MY LIKE	24		
MY SECRET	26		
CLAIRE	36		
INDISSIMA	44		
INDISSIMA CHROME	56		
GEALUNA	62		
MITO	72		
DIVO	82		
LEA	90		
ONE	102		
TOUCH	110		
RAFFAELLA	118		
FORUM QUADRA	124		
FORUM	130		
MY MIRROR	136		
COMFORT	142		

HISTORY

4 production sites for 4 categories of items

ACCESSORI DA BAGNO
SPECCHI TECNOLOGICI
MOBILI DA BAGNO
PARETI DOCCIA

BATHROOM ACCESSORIES
TECHNOLOGICAL MIRRORS
BATHROOM CABINETS
SHOWER ENCLOSURES

Inda, Gruppo Industriale italiano del settore arredobagno, con i suoi 70 anni d'esperienza è, dal 1944, al servizio di chi desidera arredare il proprio ambiente bagno con stile e funzionalità. La capacità del Gruppo di cogliere le esigenze ed i gusti di un pubblico eterogeneo in continuo cambiamento e di anticipare le tendenze dell'abitare, gli ha permesso di consolidare la leadership nei mercati internazionali.

Sono quattro le divisioni di prodotto del Gruppo: mobili, pareti doccia, accessori e specchi, tutte di produzione interna nelle quattro fabbriche Inda, per formare un pensiero unico, ideale per infinite soluzioni d'arredamento della sala da bagno. Creatività, originalità, distintiva eleganza sono elementi caratterizzanti che si esprimono nel design Inda attraverso tutte le sue forme, dal classico, al moderno, alle soluzioni più all'avanguardia, che rispondono armoniosamente all'evoluzione dell'abitare. Un progetto globale che si declina in ogni situazione architettonica, grazie all'eccezionale versatilità e dedizione delle proprie risorse creative e produttive.

Since 1944, with over 70 years of experience, Inda - Italian producer of bathroom furniture, accessories and shower enclosures - has been helping its customer to stylish and ergonomically furnish their bathrooms. The Group's ability to capture the needs and tastes of a diverse, constantly-changing public and anticipate current trends has helped it consolidate its leading place in international markets.

The Group counts four categories of items: cabinets, shower enclosures, accessories and mirrors, all of them produced internally in Inda's four production sites, to shape a unique concept, ideal for endless decor solutions of your bathroom. Inda's design arises from creativity, originality and distinctive elegance expressing on all styles from classic to modern, to the most avant-garde solutions, that respond harmoniously to the way living evolves. It is a global project that comes through in every architectural situation thanks to the exceptional versatility and dedication of its creative and productive resources.





INDA MILANO

More than a showroom

VIA PIER LOMBARDO, 30
CORNER VIA TIRABOSCHI
MILANO
indamilano@inda.net



TOTAL LIVING

A bathroom with a coordinated aesthetics.

Il bagno, oggi più che mai, è diventato uno spazio imprescindibile del nostro ambiente domestico, passando da un luogo di servizio a una vera e propria esperienza totalizzante. Per questo motivo, Inda propone diverse soluzioni di abbinamento estetico riguardanti diverse categorie di prodotto, per arredare il tuo bagno con un'estetica coordinata. Pareti doccia, mobili, accessori, specchi: tutto è perfettamente abbinato.

Today more than ever, bathrooms have become an essential space in our home environment, going from being somewhere to freshen up to a real all-encompassing experience. This is why Inda offers different matching aesthetic solutions for different product categories to furnish your bathroom with a coordinated look. Shower enclosures, furniture, accessories, mirrors: everything fits perfectly together.







Freedom of being

Inda propone un'unica soluzione cromatica per tutta la stanza da bagno, con 15 colori opachi selezionati per:

- le pareti doccia WALK IN e CLAIRE DESIGN
- gli accessori LEA, GEALUNA, MY LOVE e MY SECRET
- lo specchio PIRANO

da abbinare alle stesse finiture mobili e piani top, ai lavabi integrati Giotto e ai lavabi in appoggio in mineralguss.

Inda suggests an entire colour solution for your bathroom, with 15 selected matt shades for:

- WALK IN and CLAIRE DESIGN shower enclosures
- LEA, GEALUNA, MY LOVE and MY SECRET accessories
- PIRANO mirror

to be combined with the same finishes of cabinets and worktops, Giotto integrated washbasins and tabletop washbasins in mineral marble.



GF
Laccato opaco Grafite
Mat lacquered Grafite



TN
Laccato opaco Titanio
Mat lacquered Titanio



BD
Laccato opaco Blu denim
Mat lacquered Blu denim



AV
Laccato opaco Avio
Mat lacquered Avio



PT
Laccato opaco Platino
Mat lacquered Platino



CX
Laccato opaco Creta
Mat lacquered Creta



ST
Laccato opaco Seta
Mat lacquered Seta



MP
Laccato opaco Perla
Mat lacquered Perla

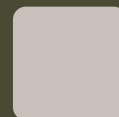

AX
Laccato opaco Avorio
Mat lacquered Avorio



VV
Laccato opaco Verde salvia
Mat lacquered Verde salvia



VF
Laccato opaco Verde felce
Mat lacquered Verde felce

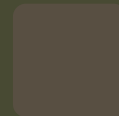

BN
Laccato opaco Bruno
Mat lacquered Bruno



VN
Laccato opaco Avana
Mat lacquered Avana



VS
Laccato opaco Visone
Mat lacquered Visone



TL
Laccato opaco Terra di Luna
Mat lacquered Terra di Luna



DESIGN BY STUDIO INDA

MY ART / MY LOVE / MY WAY / MY LIKE

New hygenical innovation.

Il design universale si adatta ad ogni contesto!
Corpo esterno, manico e coperchio in ottone cromato, base in plastica per non danneggiare le superfici, la doppia possibilità di posizionamento a parete o a terra, il trattamento antibatterico e lo scovolo sempre facilmente sostituibile, rendono questa linea la più venduta e apprezzata in ogni contesto d'arredo della stanza da bagno.

The universal design is suitable to any ambience!
The outer part, the handle and cover in chrome-plated brass, the bottom in plastic to avoid scratching surfaces, the dual chance to be installed on the wall or on the ground, the antibacterial treatment and the brush always easy to be replaced, make this series our best-selling one and the most appreciated one in every decor context of a bathroom.





MY ART / MY LOVE / MY WAY / MY LIKE

New hygenical innovation

TRATTAMENTO ANTIBATTERICO ANTIBACTERIAL TREATMENT

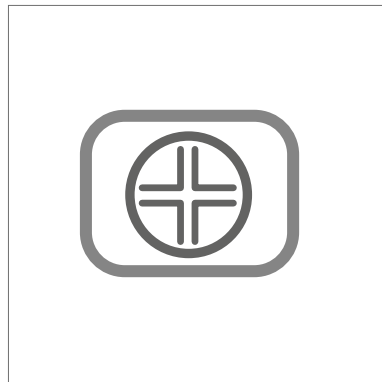

100% di igiene grazie al nuovo trattamento antibatterico delle parti in polipropilene. La sostanza igienizzante viene inserita direttamente nella materia prima garantendo l'eterna durata del trattamento.

100% hygenical thanks to the new antibacterial treatments of the polypropylene parts. The substance is placed directly into the basic material ensuring the eternal duration of treatment.

**MY ART
MY LOVE
MY WAY**

FUNZIONALITÀ FUNCTIONALITY



Innovativo sistema autocentrante: la forma conica del coperchio facilita l'inserimento dello scovolo e assicura la corretta chiusura dello scopino

Innovative self-centering-system: the conical shape of the cover simplify the insertion of the brush and ensures proper closing of the toilet brush

**MY ART
MY LOVE
MY WAY
MY LIKE**

VERSATILITÀ VERSATILITY

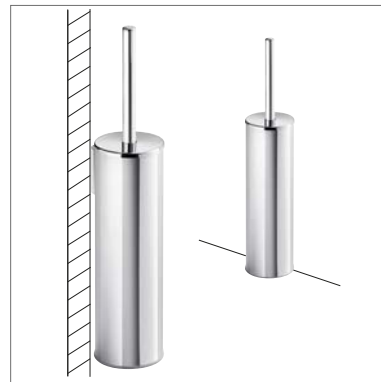

Lo stesso prodotto può essere utilizzato in appoggio o installato a parete poiché la placca per il fissaggio è sempre compresa nella confezione

The same product is suitable as free-standing or wall mounted because the wall mounting plate is always included in the package

**MY LOVE
MY WAY
MY LIKE**

RICARICABILE RECHARGEABLE



Sostituisci lo scovolo senza toccare le parti non igieniche: impugnare il coperchio e ruota il manico. La parte intercambiabile si sgancia automaticamente consentendone la sostituzione

Replace the brush without touching any unsanitary part: holding the cover and turning the handle. The interchangeable part will be released automatically allowing the substitution

**MY ART
MY LOVE
MY WAY
MY LIKE**



MY ART

#collection 22





AV014ACR01Y



AV014BNE10Y



AV014ACR02Y



AV014AWM07Y



AV014AWM09Y



AV014AWM08Y



MY ART



Imbuto di autocentraggio in plastica ABS con trattamento antibatterico
Conical self-centering cover in ABS plastic with antibacterial treatment

Fondello estraibile in plastica polipropilene con trattamento antibatterico; trattiene l'acqua di scolo dello scovolo e ne facilita la pulizia
Removable inner part in polypropylene plastic with antibacterial treatment; collect water from the brush and simplify the cleaning

Corpo esterno rivestito in carta vinilica resistente all'acqua
Outer part covered by water-resistant vinyl paper

Base in plastica polipropilene; evita il danneggiamento delle superfici e garantisce una maggiore silenziosità durante l'appoggio
Basement in polypropylene plastic; avoid the damaging of surface areas and guarantees a quiet set down

AURORA
AV014ACR01Y

Portascopino da appoggio.
Wall mounted/free-standing toilet brush
holder.
9 x 40H x 9 cm



CUBIK
AV014ACR02Y



GAME OVER
AV014ACR03Y



CARTOON
AV014AWM05Y



CALVARIAM
AV014AWM06Y



CUBA
AV014AWM07Y



URSS
AV014AWM08Y



USA
AV014AWM09Y



SKULL
AV014BCR04Y

Portascopino da appoggio.
Wall mounted/free-standing toilet brush
holder.
9 x 40H x 9 cm



TYPO
AV014BNE10Y



LA SANTA
AV014BNE12Y



GRAFFITI
AV014BNE11Y





MY LOVE

Ogni confezione singola è dotata di uno scovolo di ricambio
Every single packet has a spare part brush



Imbuto di autocentraggio in plastica ABS con trattamento antibatterico
Conical self-centering cover in ABS plastic with antibacterial treatment

Fondello estraibile in plastica polipropilene con trattamento antibatterico; trattiene l'acqua di scolo dello scovolo e ne facilita la pulizia
Removable inner part in polypropylene plastic with antibacterial treatment; collect water from the brush and simplify the cleaning

Il design universale si adatta ad ogni contesto
The universal design is suitable to any ambience

Base in plastica polipropilene; evita il danneggiamento delle superfici e garantisce una maggiore silenziosità durante l'appoggio
Basement in polypropylene plastic; avoid the damaging of surface areas and guarantees a quiet set down



AV014A CR

Portascopino da parete/da appoggio.
Scovolo di ricambio bianco incluso
Wall mounted/free-standing toilet brush
holder. White spare brush included
9 x 40H x 9 cm

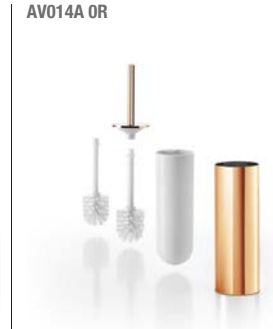
**AV014A AS****AV014A GE****AV014A CS****AV014A OR****AV014A DR****AV014A BZ****AV014A WZ****AV014A WM****AV014A WY**

AV014B CR

Portascopino da parete/da appoggio.
Scovolo di ricambio nero incluso
Wall mounted/free-standing toilet brush
holder. Black spare brush included
9 x 40H x 9 cm

**AV014B CG****AV014B NE****AV014B NC****AV014B AC****AV014B C0****AV014B RM****AV014B ML**

AV014A GF

Grafitte
 Portascopino da parete/da appoggio.
 Scovolo di ricambio bianco incluso
 Wall mounted/free-standing toilet brush
 holder. White spare brush included
 9 x 40H x 9 cm

**AV014A TN**

Titanio

**AV014A BD**

Blu denim

**AV014A AV**

Avio

**AV014A PT**

Platino



YOUR OWN COLOR
 > page 6

AV014A CX

Creta

**AV014A ST**

Seta

**AV014A MP**

Perla

**AV014A AX**

Avorio

**AV014A VV**

Verde salvia

**AV014A VF**

Verde felce

**AV014A BN**

Bruno

**AV014A VN**

Avana

**AV014A VS**

Visone

**AV014A TL**

Terra di Luna



* Disponibili secondo le condizioni
 di vendita del progetto YOUR OWN
 COLOR

* Available according to the sales
 conditions of the project YOUR
 OWN COLOR

AV014B GF

Grafite
 Portascopino da parete/da appoggio.
 Scovolo di ricambio nero incluso
 Wall mounted/free-standing toilet brush holder. Black spare brush included
 9 x 40H x 9 cm

**AV014B TN**

Titanio

**AV014B BD**

Blu denim

**AV014B AV**

Avio

**AV014B PT**

Platino



YOUR OWN COLOR
 > page 6

AV014B CX

Creta

**AV014B ST**

Seta

**AV014B MP**

Perla

**AV014B AX**

Avorio

**AV014B VV**

Verde salvia

**AV014B VF**

Verde felce

**AV014B BN**

Bruno

**AV014B VN**

Avana

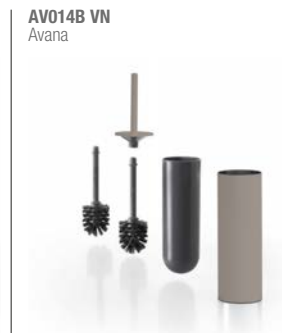
**AV014B VS**

Visone

**AV014B TL**

Terra di Luna



* Disponibili secondo le condizioni di vendita del progetto YOUR OWN COLOR

* Available according to the sales conditions of the project YOUR OWN COLOR



MY WAY



Imbuto di autocentraggio in plastica ABS con trattamento antibatterico
Conical self-centering cover in ABS plastic with antibacterial treatment

Fondello estraibile in plastica polipropilene con trattamento antibatterico; trattiene l'acqua di scolo dello scovolo e ne facilita la pulizia
Removable inner part in polypropylene plastic with antibacterial treatment; collect water from the brush and simplify the cleaning

Il design universale si adatta ad ogni contesto
The universal design is suitable to any ambience

Base in plastica polipropilene; evita il danneggiamento delle superfici e garantisce una maggiore silenziosità durante l'appoggio
Basement in polypropylene plastic; avoid the damaging of surface areas and guarantees a quiet set down

AV114A CR

Portascopino da parete/da appoggio
Wall mounted/free-standing toilet brush
holder
9 x 40H x 9 cm

**AV114A AS****AV114A WM****AV114B CR**

Portascopino da parete/da appoggio
Wall mounted/free-standing toilet brush
holder
9 x 40H x 9 cm

**AV114B NE**



MY LIKE



AV414A AL

Portascopino da parete/da appoggio
Wall mounted/free-standing toilet brush
holder
8 x 38H x 8 cm

**AV414A NS****AV414B NE**

Portascopino da parete/da appoggio
Wall mounted/free-standing toilet brush
holder
8 x 38H x 8 cm



DESIGN BY GREY ID

MY SECRET

For an even more exclusive bathroom

My secret: un nuovo concetto di spazio dove l'accessorio da bagno scompare! Un design versatile, un innovativo sistema di incasso a muro - totale o a semincasso o esterno - e una gamma di 10 colori, rendono My secret un componente trasversale che si adatta ad ogni tipo di soluzione, offrendo minimo ingombro e massima funzionalità.

My secret: a new concept of space where the accessory can be tucked away! A versatile design, an innovative wall cabinet system - that can be fully, semi or non-recessed - and a range of 10 colors, make My Secret a transversal element which can fit any bathroom solution, occupying minimum space for maximum practical appeal.



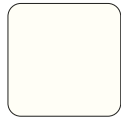

BX
Laccato opaco Bianco
Mat lacquered Bianco



CE
Laccato opaco Cemento
Mat lacquered Cemento



NX
Laccato opaco Nero
Mat lacquered Nero



TL
Laccato opaco Terra di Luna
Mat lacquered Terra di Luna



AQ
Laccato opaco Aquamarina
Mat lacquered Aquamarina



YOUR OWN COLOR
> page 6



MP
Laccato opaco Perla
Mat lacquered Perla



CX
Laccato opaco Creta
Mat lacquered Creta



AX
Laccato opaco Avorio
Mat lacquered Avorio



BN
Laccato opaco Bruno
Mat lacquered Bruno



GD
Laccato opaco Giada
Mat lacquered Giada









A80750

Modulo da incasso con portabicchiere e spandisapone
 Recessed modul with tumbler holder and soap dispenser
 35 x 26H x 15 cm

**A8085A**

Modulo da incasso con portarotolo e portascopino My Love
 Recessed modul with paper holder and My Love toilet brush holder
 19 x 66H x 15 cm

**A8085C**

Modulo da incasso con portarotolo, portarotolo di scorta e My Love
 Recessed modul with paper holder, spare roll holder and My Love
 19 x 86H x 15 cm



Modulo da incasso con portarotolo, portarotolo di scorta e idroscopino
 Recessed modul with paper holder, spare roll holder and hydrobrush
 19 x 86H x 15 cm

**A8085B**

Modulo da incasso con portarotolo e idroscopino
 Recessed modul with paper holder and hydrobrush
 19 x 66H x 15 cm

**A8035A**

Modulo da incasso con mensole in vetro, anta battente con specchio interno
 Recessed modul with glass shelves, pivot door with internal mirror
 35 x 160H x 15 cm



A8035B

Modulo da incasso con mensole in vetro, portasciugacapelli, anta battente con specchio interno
 Recessed modul with glass shelves, hairdryer holder, pivot door with internal mirror
 35 x 160H x 15 cm

**A8035C**

Modulo da incasso con mensole in vetro
 Recessed modul with glass shelves
 35 x 160H x 15 cm

**A80760**

Modulo da semincasso con portabicchiere e spandisapone
 Half built-in modul with tumbler holder and soap dispenser
 35 x 26H x 15 cm

**A8086A**

Modulo da semincasso con portarotolo e portascopino My love
 Half built-in modul with paper holder and My love toilet brush holder
 19 x 66H x 15 cm

**A8086C**

Modulo da semincasso con portarotolo, portarotolo di scorta e My Love
 Half built-in modul with paper holder, spare roll holder and My Love
 19 x 86H x 15 cm



A8036A

Modulo da semincasso con
mensole in vetro, anta battente con
specchio interno
Half built-in modul with glass
shelves, pivot door with internal
mirror
35 x 160H x 15 cm

**A8036B**

Modulo da semincasso
con mensole in vetro,
portasciugacapelli, anta battente
con specchio interno
Half built-in modul with glass
shelves, hairdryer holder, pivot
door with internal mirror
35 x 160H x 15 cm

**A8036C**

Modulo da semincasso con
mensole in vetro
Half built-in modul with glass
shelves
35 x 160H x 15 cm

**A8037A**

Modulo esterno con mensole in
vetro, anta battente con specchio
interno
External modul with glass
shelves, pivot door with internal
mirror
35 x 160H x 17 cm

**A8037B**

Modulo esterno con mensole in
vetro, portasciugacapelli, anta
battente con specchio interno
External modul with glass shelves,
hairdryer holder, pivot door with
internal mirror
35 x 160H x 17 cm

**A8037C**

Modulo esterno con mensole in
vetro
External modul with glass shelves
35 x 160H x 17 cm



A8038A

Modulo esterno con mensole in vetro, anta battente con specchio interno
 External modul with glass shelves, pivot door with internal mirror
 35 x 160H x 17 cm

**A8038B**

Modulo esterno con mensole in vetro, portasciugacapelli, anta battente con specchio interno
 External modul with glass shelves, hairdryer holder, pivot door with internal mirror
 35 x 160H x 17 cm



DESIGN BY DANIEL DEBIASI & FEDERICO SANDRI

CLAIRE

Windy and modern shape

Forme sinuose e moderne coniugano solidità ed eleganza in un'estetica originale. Le finiture e gli elementi più innovativi si uniscono a quelli più tradizionali per offrire una serie completa dal carattere europeo.

Windy and modern shapes combine solidity and elegance in a unique aesthetics. The most innovative finishes and elements integrate the more traditional ones to present a complete series with a European character.



click 

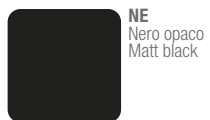
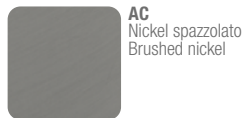







A7118
Portasalviette
Towel holder
32 / 47 / 62 / 82 x 3H x 8 cm



click

A7120C
Gancio portasalvietta
Towel hook
2 x 4H x 5 cm



click

A71180
Portasalviette doppio
Double towel holder
29 x 3H x 7 cm



click

A71150
Portasalviette fisso a bandiera
Fixed towel holder
2 x 6H x 39 cm



A7115A
Portasalviette doppio fisso a bandiera
Flag fixed double towel holder
7 x 3H x 39 cm



A7120A
Appendiabiti
Clothes hanger
2 x 4H x 5 cm



click

A7120B
Appendiabiti doppio
Double clothes hanger
8 x 4H x 6 cm



click

A7178
Portabicchiere con portasapone/
portaoggetti a parete destro/sinistro
Wall-mounted tumbler holder with right/
left soap holder/objects holder
19 x 10H x 11 cm



A7178
Spandisapone a leva con portaoggetti
a parete destro/sinistro. Leva in
finitura
Wall-mounted lever soap dispenser
with right/left objects holder. Lever
in finish
19 x 12H x 11 cm



0,25 Lt.

A7110F
Portabicchiere a parete con due
bicchieri
Wall-mounted tumbler holder
with two tumblers
19 x 10H x 11 cm



A7110D
Portabicchiere con spandisapone a
leva a parete. Leva in finitura
Wall-mounted tumbler holder with
lever soap dispenser. Lever in finish
19 x 12H x 11 cm



0,25 Lt.

A7110Z
Portabicchiere con portasapone/
portaoggetti da appoggio
Tabletop tumbler holder with
soap holder/objects holder
19 x 11H x 11 cm



A7110W
Portabicchiere doppio da
appoggio
Tabletop double tumbler holder
19 x 11H x 11 cm



A71250
Portarotolo reversibile
Reversible paper holder
13 x 4H x 8 cm



click **REV**



A71260
Portarotolo con coperchio
basculante richiudibile
Paper holder with tilting
closeable cover
14 x 11H x 3 cm



A7125B
Portarotolo basculante
Tilting roll holder
14 x 11H x 2 cm



A71280
Portarotolo di scorta doppio
Spare double paper holder
3 x 23H x 8 cm



click



A71950
Maniglione di sicurezza
Safety grip
42 x 4H x 6 cm



1.500N
~150Kg



A7114A
Portascopino da parete con
bacinella in vetro satinato -
scovolo bianco
Wall-mounted toilet brush
holder, with satined glass dish -
white brush
10 x 39H x 11 cm



A7114B
Portascopino da parete con
bacinella in vetro fumè - scovolo
nero
Wall-mounted toilet brush
holder, with satined smoked
glass dish - black brush
10 x 39H x 11 cm



DESIGN BY MATTEO THUN & ANTONIO RODRIGUEZ

INDISSIMA

Immediate functionality and essential design.

Una serie versatile e pratica ma allo stesso tempo sofisticata e di grande personalità, pensata per caratterizzare l'ambiente bagno in ogni sua declinazione, grazie alle diverse finiture e all'unione di materiali differenti.

A versatile and practical serie but at the same time sophisticated and of great personality, designed to characterize the bathroom environment in all its forms, thanks to the different finishes and the combination of different materials.





NS
Acciaio inox spazzolato AISI 304
Brushed stainless steel AISI 304



HPL
Textil ice

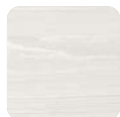

HPL
Larice panna

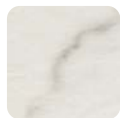

HPL
Calacatta

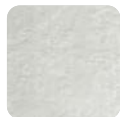

HPL
Malta



HPL
Fiore bianco



HPL
Yard



NE
Nero opaco
Matt black



HPL
Textil grey



HPL
Larice sand



HPL
Porfido



HPL
Pietra chiara



HPL
Fiore nero



WM
Bianco opaco
Matt white



HPL
Textil brown

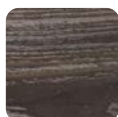

HPL
Larice brown



HPL
Pietra scura



HPL
Cemento scuro



HPL
Lava



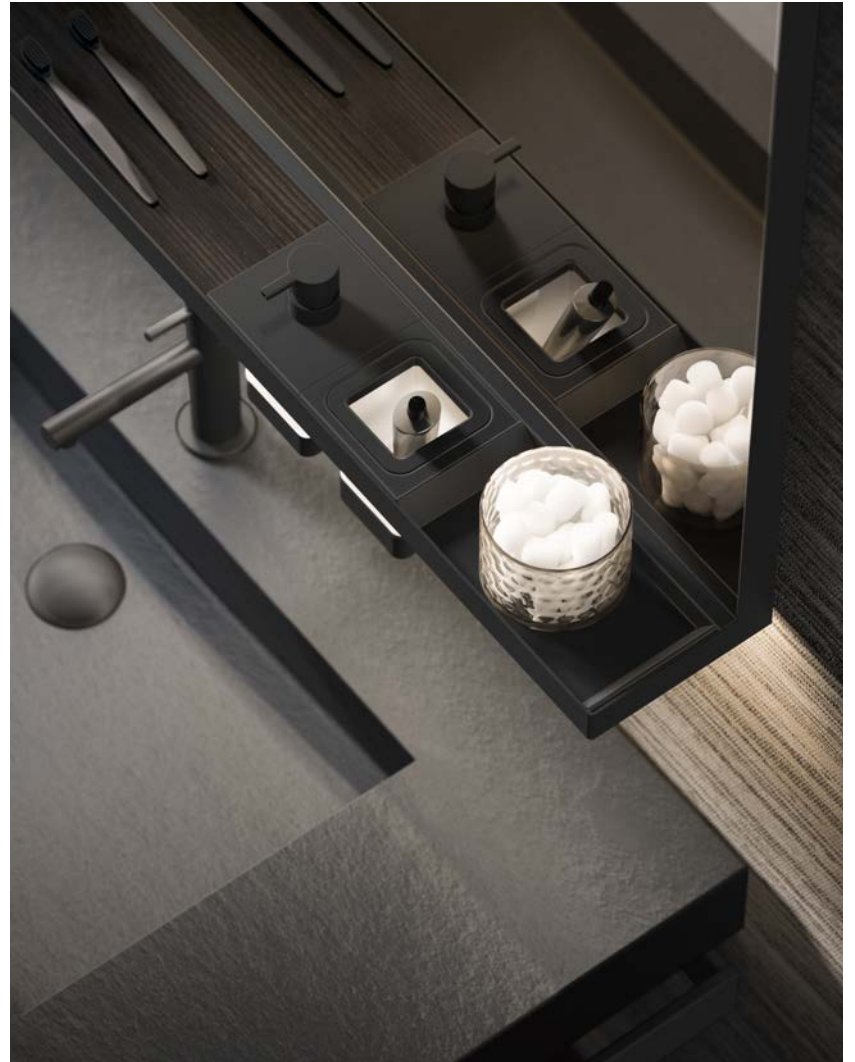

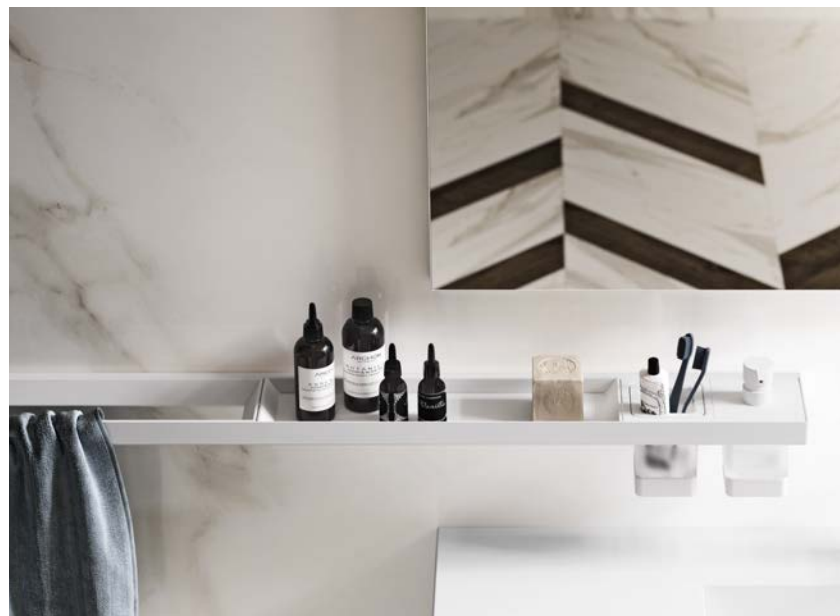







A8883
Barra modulare
Modular bar
20 / 30 / 40 / 60 / 80 / 100 x 3H x 11 cm



A8883
Barra modulare con luce led, adatta per
posizionamento sotto specchio
Modular bar with led light, suitable for positioning
under the mirror
60 / 80 / 100 / 120 / 140 / 160 x 3H x 14 cm

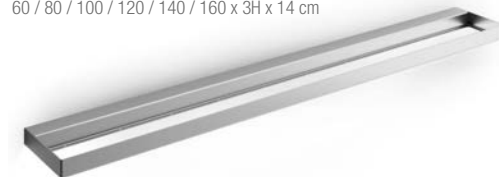

A8883
Barra modulare adatta per posizionamento
sottospecchio
Modular bar suitable for positioning under the
mirror
60 / 80 / 100 / 120 / 140 / 160 x 3H x 14 cm



A8818
Modulo portasalviette
Towel holder module
30 / 40 / 60 / 80 x 3H x 10 cm



A8812M
Modulo spandisapone
Soap spreading module
10 x 15H x 10 cm



0,25 Lt.



A8867M
Modulo spandisapone a leva
Soap dispenser module with lever
10 x 12H x 10 cm



0,18 Lt.



A8810M
Modulo bicchiere
Glass module
10 x 11H x 10 cm



A8810N
Modulo bicchiere
Glass module
10 x 11H x 10 cm



A8809
Modulo mensola bassa
Low shelf module
20 / 40 x 3H x 10 cm



HPL

A8809
Modulo mensola
Shelf module
20 / 40 x 3H x 10 cm



HPL

A8851N
Modulo cestino basso
Low basket module
20 x 3H x 10 cm



A8851M
Modulo cestino
Basket module
20 x 3H x 10 cm



A8826

Modulo portarotolo destro o sinistro con coperchio
 Right or left roll holder module with lid
 20 x 10H x 10 cm

**A8842M**

Modulo porta sacchetti igienici
 Hygienic bag holder module
 10 x 3H x 10 cm

**A8801M**

Modulo gettacarta
 Paper basket module
 20 x 25H x 10 cm



3,5 Lt.

A8814M

Modulo portascopino con fondello estraibile
 Brush holder module with removable bottom
 10 x 40H x 10 cm



A8818
Portasalviette
Towel holder
42 / 62 / 82 x 3H x 7 cm

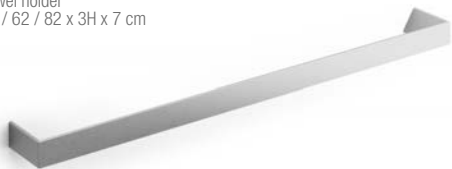

A8815
Portasalviette fisso a bandiera
Fixed towel holder
4 x 3H x 40 cm

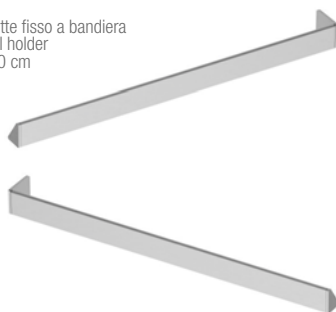

A88680
Portateli
Bath towel rack
62 x 3H x 23 cm



click

click

A8820A
Appendiabiti
Clothes hanger
4 x 3H x 3 cm



A88670
Spandisapone a leva a parete
con contenitore in vetro
satinato, leva in finitura
Wall-mounted lever soap
dispenser with satinized glass
container, lever in finish
7 x 12H x 10 cm



click 0,18 Lt.

A88120
Spandisapone a parete con contenitore
in vetro satinato, erogatore in finitura
Wall-mounted soap dispenser with
satinized glass container and in finish
brass pump
7 x 15H x 10 cm



click 0,25 Lt.

A88100
Portabicchiere a parete con
bicchiere in vetro satinato
Wall-mounted tumbler holder
with satinized glass tumbler
7 x 10H x 10 cm

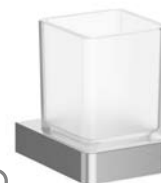

click

A88110
Portasapone a parete con
bacinella in vetro satinato
Wall-mounted soap holder with
satinized glass dish
12 x 4H x 12 cm



click

A8825
Portarotolo destro o sinistro
Right or left roll holder
15 x 3H x 10 cm



A88280
Portarotolo di scorta doppio
Spare double paper holder
3 x 24H x 8 cm



A88510
Cestino
Basket
22 x 3H x 10 cm

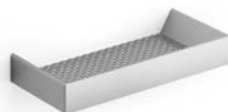

click

AV114
Portascopino da parete/da appoggio
Wall mounted/free-standing toilet brush holder
9 x 40H x 9 cm





DESIGN BY MATTEO THUN & ANTONIO RODRIGUEZ

INDISSIMA CHROME

Precise and refined geometries.

Un'accurata selezione di accessori Indissima anche in finitura cromata, perfetta per adattarsi facilmente a tutte le stanze da bagno dallo stile moderno e minimale.

A rigorous selection of Indissima accessories also in a chrome finish, perfect for easily adapting to any bathroom with a modern and minimal style.

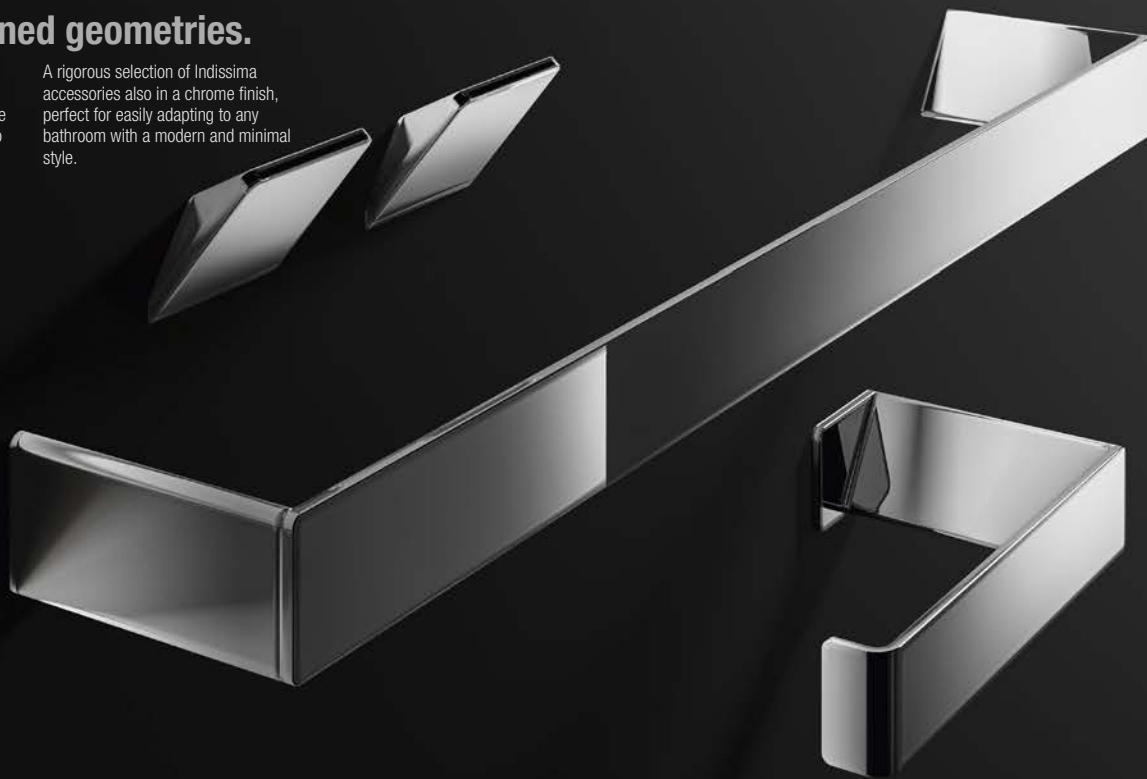



click



CR
Cromato
Chrome-plated



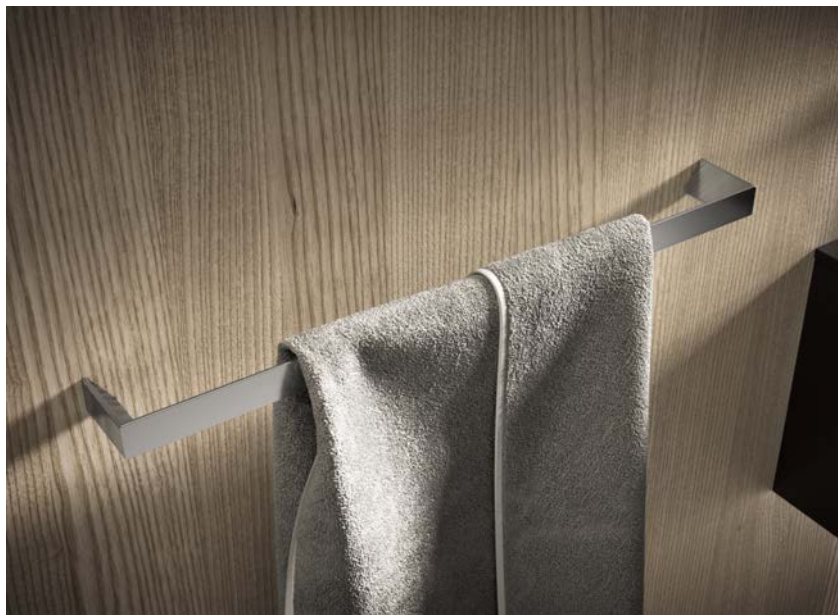

A8818
Portasalviette
Towel holder
42 / 62 / 82 x 3H x 7 cm



click

A8815
Portasalviette fisso a bandiera
Fixed towel holder
4 x 3H x 40 cm

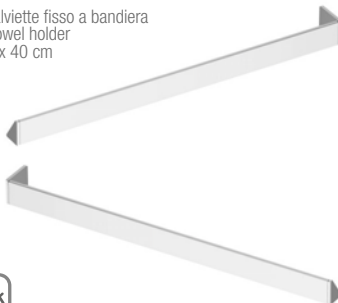

click

A88680
Portateli
Bath towel rack
62 x 3H x 23 cm



A8820A
Appendiabiti
Clothes hanger
4 x 3H x 3 cm



A88K20
Set lavabo (spandisapone a leva
con portabicchiere)
Washbasin set (lever soap
dispenser with tumbler holder)
21 x 12H x 12 cm



A88K30
Set lavabo (spandisapone con
portabicchiere)
Washbasin set (soap dispenser
with tumbler holder)
20 x 12H x 12 cm



A88K40
Set lavabo (spandisapone con
portabicchiere e mensola)
Washbasin set (soap dispenser
with tumbler holder and shelf)
40 x 12H x 12 cm



A88670
Spandisapone a leva a parete con
contenitore in vetro satinato, leva
in finitura
Wall-mounted lever soap
dispenser with satinated glass
container, lever in finish
7 x 12H x 10 cm



click

0,18 Lt.

A88120
Spandisapone a parete con
contenitore in vetro satinato,
erogatore in finitura
Wall-mounted soap dispenser with
satinated glass container and in finish
brass pump
7 x 15H x 10 cm



click

0,25 Lt.

A88100
Portabicchiere a parete con
bicchiere in vetro satinato
Wall-mounted tumbler holder
with satinated glass tumbler
7 x 10H x 10 cm



click

A88110

Portasapone a parete con
bacinella in vetro satinato
Wall-mounted soap holder with
satinated glass dish
12 x 4H x 12 cm



click

A88K5

Portarotolo destro o sinistro con coperchio
Right or left roll holder with lid
20 x 10H x 12 cm

**A8825**

Portarotolo
Paper holder
15 x 3H x 10 cm

**A88280**

Portarotolo di scorta doppio
Spare double paper holder
3 x 24H x 8 cm

**A88510**

Cestino
Basket
22 x 3H x 10 cm



click

AV114

Portascopino da parete/da appoggio
Wall mounted/free-standing toilet brush holder
9 x 40H x 9 cm



DESIGN BY STUDIO INDA

GEALUNA

Elegance matches rigorous design.

Un'estetica estremamente essenziale e di grande eleganza, con l'utilizzo di materiali di assoluta qualità, è la caratteristica principale di Gealuna, una collezione dal design rigoroso, distinto da linee nette e pulite. La serie può essere montata a parete utilizzando la colla per evitare la foratura delle ceramiche oppure con viti e tasselli.

An extremely essential look and of great elegance with the use of absolute top quality materials. Gealuna rigorous design, stands out for its clean, sharp lines. The series can be mounted to the wall using glue does not require to make a hole of ceramics or with screws and dowels.







CR
Cromato
Chrome-plated



NS
Acciaio inox spazzolato AISI 304
Brushed stainless steel AISI 304



YOUR OWN COLOR
> page 6













A1018
Portasalviette
Towel holder
35 / 50 / 65 / 85 x 5H x 9 cm



A1018
Portasalviette senza placca a muro
Towel holder without wall plate
32 / 47 / 62 / 82 x 2H x 9 cm



A10150
Portasalviette doppio a snodo
Double swing arm towel holder
5 x 9H x 37 cm



A10160
Portasalviette ad anello
Ring towel holder
18 x 20H x 6 cm



A1019
Portasalviette doppio
Double towel holder
50 / 65 x 5H x 12 cm



A1019
Portasalviette doppio senza placca a muro
Double towel holder without wall plate
47 / 62 x 2H x 12 cm



A10680
Portateli con portasalviette
Bath towel rack with towel holder
60 x 12H x 29 cm

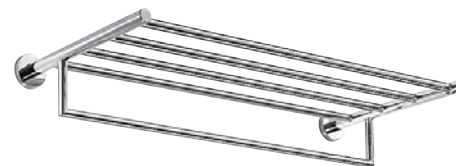

A1020A
Appendiabiti
Clothes hanger
5 x 5H x 6 cm



A1020B
Appendiabiti doppio
Double clothes hanger
15 x 5H x 5 cm



A1020C
Appendiabiti
Clothes hanger
7 x 5H x 6 cm



A10120
Spandisapone a parete con
contenitore in vetro extrachiaro
trasparente, erogatore in finitura
trasparente
Wall-mounted soap dispenser
with extra clear transparent glass
container and in
finish brass pump
8 x 16H x 12 cm



A1010A
Portabicchiere a parete con
bicchiere in vetro extrachiaro
trasparente
Wall-mounted tumbler holder
with extra clear transparent glass
tumbler
8 x 11H x 12 cm



A10110

Portasapone a parete con
bacinella in vetro extrachiario
trasparente
Wall-mounted soap holder with
extra clear transparent glass dish
13 x 5H x 15 cm

**A1025**

Portarotolo
Paper holder
18 x 5H x 9 cm

**A1025B**

Portarotolo basculante
Tilting roll holder
14 x 10H x 6 cm

**A1025C**

Portarotolo doppio
Double paper holder
29 x 5H x 9 cm

**A10260**

Portarotolo basculante con
coperchio
Tilting roll holder with cover
16 x 15H x 6 cm

**A10280**

Portarotolo di scorta
Spare roll holder
5 x 18H x 9 cm

**A1031B**

Angolare
Corner
21 x 2H x 21 cm

**A1051B**

Cestino
Basket
29 x 3H x 13 cm

**A10950**

Maniglione di sicurezza
Safety grip
36 x 5H x 6 cm

**A1095**

Maniglione di sicurezza
Safety grip
51 / 66 x 5H x 6 cm

**AV014A**

Portascopino da parete/da appoggio.
Scovolo di ricambio incluso
Wall mounted/free-standing toilet brush holder.
Spare brush included
9 x 40H x 9 cm

**R10000A**

Adesivo in pasta
Paste adhesive



MITO

Simplicity and refinement.

Mito è una serie di accessori in ottone cromato indicata per arredare con semplicità ed eleganza. Grazie ad un innovativo sistema di fissaggio a "scatto", il montaggio a parete viene estremamente facilitato.

Mito is a series of accessories in chromium plated brass to furnish with simplicity and elegance; thanks to an innovative fixing system "clip", the wall assembly is extremely facilitated.









click 

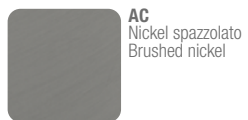







A2018
Portasalviette
Towel holder
34 / 49 / 64 / 84 x 2H x 8 cm



click



A20150
Portasalviette doppio a snodo
Double swing arm towel holder
2 x 9H x 40 cm



A2018M
Portasalviette laterale per mobile
Lateral towel holder for cabinet
38 x 2H x 8 cm



click

REV



A20160
Portasalviette ad anello
Ring towel holder
28 x 16H x 8 cm



click



A2020A
Appendiabiti
Clothes hanger
2 x 6H x 4 cm



click



A2020B
Appendiabiti doppio
Double clothes hanger
9 x 3H x 4 cm



click



A20670
Spandisapone a leva a parete
con contenitore in vetro satinato,
leva in finitura
Wall-mounted lever soap
dispenser with satinized glass
container, lever in finish
8 x 13H x 12 cm



click

0,25 Lt.



A20120
Spandisapone a parete con contenitore
in vetro satinato, erogatore in finitura
Wall-mounted soap dispenser with
satinized glass container and in finish
brass pump
8 x 16H x 12 cm



click

0,25 Lt.



A2012B
Spandisapone a parete con
contenitore in vetro satinato,
erogatore in finitura
Wall-mounted soap dispenser with
satinized glass container and in finish
brass pump
8 x 15H x 12 cm



0,35 Lt.



A20100
Portabicchiere a parete con
bicchiere in vetro satinato
Wall-mounted tumbler holder
with satinized glass tumbler
8 x 10H x 12 cm



click



A20110
Portasapone a parete con bacinella
in vetro satinato
Wall-mounted soap holder with
satinized glass dish
13 x 4H x 14 cm



click

A20060
Spandisapone da appoggio, con
contenitore in vetro satinato ed
erogatore in finitura
Tabletop soap dispenser with satinized
glass container and pump in finishing
8 x 16H x 8 cm



0,35 Lt.



A20010

Portabicchiere da appoggio con
bicchiere in vetro satinato
Tabletop tumbler holder with
satinated glass tumbler
8 x 10H x 8 cm

**A20020**

Portasapone da appoggio con
bacinella in vetro satinato
Tabletop soap holder with satinated
glass dish
13 x 5H x 13 cm

**A2025**

Portarotolo
Paper holder
17 x 3H x 8 cm



click

**A20260**

Portarotolo basculante con
coperchio
Tilting roll holder with cover
15 x 9H x 5 cm



click

**A2028A**

Portarotolo di scorta
Spare roll holder
2 x 16H x 8 cm



click

**AV014**

Portascopino da parete/da appoggio.
Scovolo di ricambio incluso
Wall mounted/free-standing toilet brush holder.
Spare brush included
9 x 40H x 9 cm

**AV114**

Portascopino da parete/da appoggio
Wall mounted/free-standing toilet brush holder
9 x 40H x 9 cm



DIVO

Pragmatic and essential design.

Divo è una serie di accessori dal carattere forte e deciso, espressione di un design pragmatico ed essenziale che si esprime attraverso linee pulite e squadrate. L'assenza della placca di fissaggio a muro diventa espressione di un gusto contemporaneo minimale che si esprime con un "segno" che caratterizza lo spazio.

Divo is a serie of accessories with strong character, expression of a pragmatic and essential design that is expressed through clean and squared lines. The absence of the fixing plaque to the wall becomes an expression of a contemporary minimalist taste which is expressed by a "sign" that characterizes the space.







CR
Cromato
Chrome-plated



NE
Nero opaco
Matt black



BZ
Bronzo
Bronzed
ON REQUEST









A1518
Portasalviette
Towel holder
32 / 47 / 62 / 82 x 2H x 9 cm



A15150
Portasalviette doppio a snodo
Double swing arm towel holder
2 x 8H x 39 cm



A1520A
Appendiabiti
Clothes hanger
2 x 8H x 3 cm



A15120
Spandisapone a parete con
contenitore in vetro extrachiaro
trasparente o satinato, erogatore
in finitura
Wall-mounted soap dispenser
with extra clear transparent or
satinated glass container and in
finish brass pump
11 x 16H x 11 cm



0,25 Lt.

A15110
Portasapone a parete con
bacinella in vetro extrachiaro
trasparente o satinato
Wall-mounted soap holder with
extra clear transparent or satinated
glass dish
11 x 4H x 11 cm



0,25 Lt.

A15100
Portabicchiere a parete con
bicchiere in vetro extrachiaro
trasparente o satinato
Wall-mounted tumbler holder with
extra clear transparent or satinated
glass tumbler
11 x 11H x 11 cm



A2012Z
Spandisapone da appoggio, con
contenitore in vetro extrachiaro
trasparente o satinato ed
erogatore in finitura
Tabletop soap dispenser with
extra clear transparent or satinated
glass container and pump in
finishing
9 x 16H x 9 cm



0,25 Lt.

A2011Z
Portasapone da appoggio con
bacinella in vetro extrachiaro
trasparente o satinato
Tabletop soap holder with extra clear
transparent or satinated glass dish
11 x 4H x 11 cm



A2010Z
Portabicchiere da appoggio con
bicchiere in vetro extrachiaro
trasparente o satinato
Tabletop tumbler holder with extra
clear transparent or satinated glass
tumbler
9 x 11H x 9 cm



A1525B
Portarotolo
Paper holder
18 x 2H x 9 cm



A1527A
Portarotolo con coperchio
portacellulare
Toilet roll holder with mobile phone
holder
17 x 10H x 12 cm



click

A15490
Cestino
Basket
21 x 2H x 11 cm



A15510

Cestino con ripiano asportabile
Basket with removable shelf
52 x 2H x 11 cm

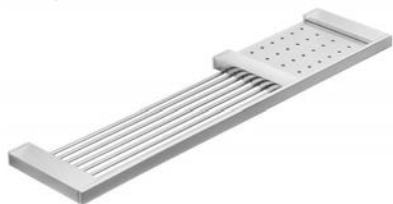
**A33850**

Piantana con 2 portasalviette
Stand with 2 towel holders
24 x 88H x 40 cm

**AV114**

Portascopino da parete/da appoggio
Wall mounted/free-standing toilet
brush holder
9 x 40H x 9 cm



LEA

Accessories for every need.

Lea, funzionalità essenziale. Voglia di nuove geometrie con la purezza della forma a sezione rettangolare, un sistema completo di accessori che soddisfa, con proposte mirate, tutte le esigenze e le funzioni dell'arredobagno!

La serie può essere montata a parete utilizzando il kit da incollo per evitare la foratura delle ceramiche oppure con viti e tasselli.

Lea, essential functionality. Desire for new geometries with the purity of a rectangular section form, a complete system of accessories that meets with specific proposals the needs and functions of bathroom design!

The series can be wall-mounted using the glue from the kit to avoid drilling of ceramics or installed with screws and dowels.

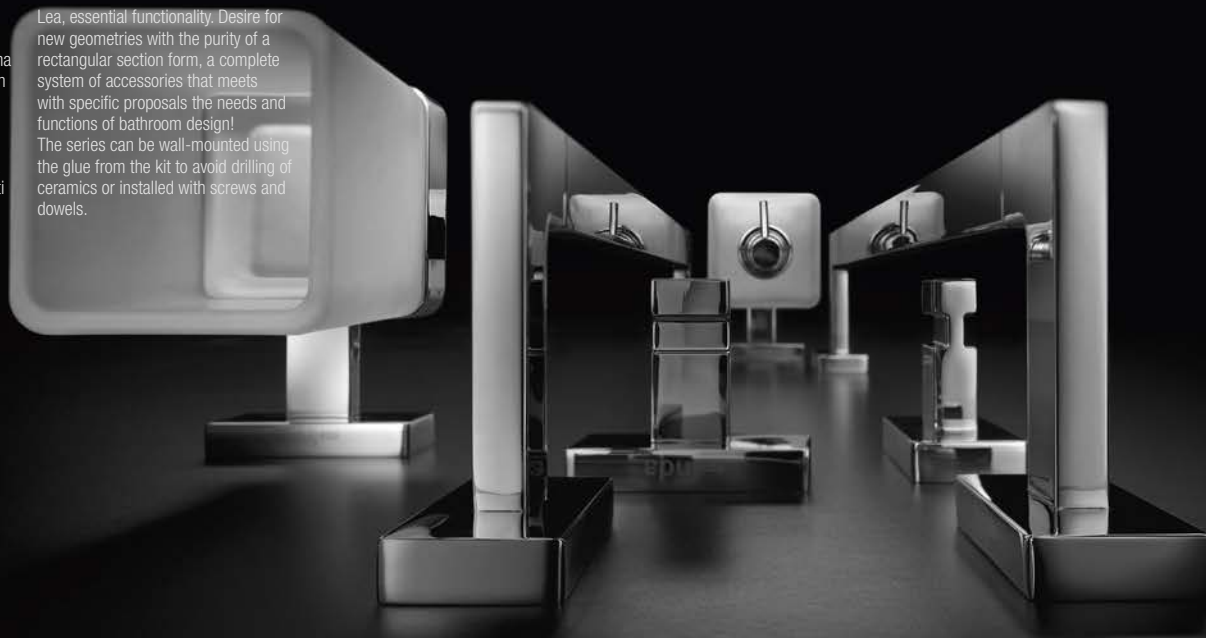





CR
Cromato
Chrome-plated



OR
Oro rosato lucido
Glossy rose-coloured gilded



DR
Dorato 24 carati
Gilded 24 carats



BZ
Bronzo
Bronzed



YOUR OWN COLOR
> page 6



AC
Nickel spazzolato
Brushed nickel



CG
Cromo nero spazzolato
Brushed black chrome



NE
Nero opaco
Matt black

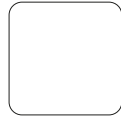

WM
Bianco opaco
Matt white











96_LEA





R1800N

Kit fissaggio a parete
 opzionale. Include
 confezione colla
 Optional wall mounting kit.
 Includes glue pack
 6 x 3H x 1 cm

**A1818**

Portasalviette
 Towel holder
 36 / 51 / 66 / 86 x 3H x 8 cm

**A1819**

Portasalviette doppio
 Double towel holder
 51 / 66 x 3H x 13 cm

**A18160**

Portasalviette ad anello
 Ring towel holder
 22 x 14H x 6 cm

**A1815**

Portasalviette fisso a bandiera
 Flag fixed towel holder
 6 x 3H x 32 / 45 cm

**A1815A**

Portasalviette doppio a snodo
 Double swing arm towel holder
 7 x 4H x 38 cm

**A18680**

Portateli con portasalviette
 Bath towel rack with towel holder
 66 x 9H x 25 cm

**A1820A**

Appendiabiti
 Clothes hanger
 6 x 3H x 5 cm

**A1820B**

Appendiabiti doppio
 Double clothes hanger
 11 x 3H x 5 cm

**A1820C**

Appendiabiti triplo
 Triple clothes hanger
 17 x 3H x 5 cm

**A18670**

Spandisapone a leva
 Soap dispenser with lever
 7 x 12H x 11 cm



0,18 Lt.

**A18120**

Spandisapone a parete con
 contenitore in vetro satinato,
 erogatore in finitura
 Wall-mounted soap dispenser with
 satinated glass container and in finish
 brass pump
 7 x 15H x 11 cm



0,25 Lt.

A18100

Portabicchiere a parete con bicchiere in vetro satinato
Wall-mounted tumbler holder with satined glass tumbler
7 x 11H x 11 cm

**A18110**

Portasapone a parete con bacinella in vetro satinato
Wall-mounted soap holder with satined glass dish
12 x 5H x 13 cm

**A1810D**

Supporto doppio a parete con bicchiere e spandisapone in vetro satinato, erogatore in finitura
Wall-mounted double support with satined glass tumbler and soap dispenser in finish brass pump
20 x 15H x 11 cm



0,25 Lt.

A1810F

Portabicchiere a parete con 2 bicchieri in vetro satinato
Wall-mounted tumbler holder with 2 satined glass tumblers
20 x 11H x 11 cm

**A1812Z**

Spandisapone da appoggio, con contenitore in vetro satinato ed erogatore in finitura
Tabletop soap dispenser with satined glass container and pump in finishing
7 x 15H x 8 cm



0,25 Lt.

A1810Z

Portabicchiere da appoggio con bicchiere in vetro satinato
Tabletop tumbler holder with satined glass tumbler
7 x 10H x 7 cm

**A1811Z**

Portasapone da appoggio con bacinella in vetro satinato
Tabletop soap holder with satined glass dish
12 x 4H x 12 cm

**A1825**

Portarotolo
Paper holder
19 x 3H x 8 cm

**A1825B**

Portarotolo doppio
Double paper holder
31 x 3H x 8 cm

**A18260**

Portarotolo basculante con coperchio
Tilting roll holder with cover
15 x 10H x 5 cm

**A1826A**

Portarotolo con coperchio
Paper holder with cover
17 x 2H x 13 cm

**A18280**

Portarotolo di scorta
Spare roll holder
6 x 17H x 8 cm



A18310
 Angolare
 Corner
 16 x 7H x 17 cm



A18510
 Cestino
 Basket
 20 x 7H x 13 cm



A1849A
 Cestino
 Basket
 15 x 3H x 10 cm



A1851A
 Cestino
 Basket
 25 x 3H x 12 cm



A18090
 Mensola in cristallo satinato temperato 6
 mm con supporti
 Tempered satined crystal shelf, 6 mm
 glass, with brackets
 60 x 3H x 13 cm



A1895
 Maniglione di sicurezza
 Safety grip
 30 / 45 / 60 x 3H x 5 cm



1.500N
 ~150Kg

A1814
 Portascopino da parete con bacinella in
 vetro satinato
 Wall-mounted toilet brush holder, with
 satined glass dish
 10 x 35H x 13 cm





ONE

Simply unique.

La semplicità ha un nuovo nome: One. La collezione di accessori per il bagno disegnata da Matteo Thun e Antonio Rodriguez combina elementi lineari e puliti. La vastità dell'assortimento e la chiarezza formale rendono One una soluzione particolarmente flessibile sia dal punto di vista stilistico che pratico. La collezione One si adatta sia ad ambienti pubblici che residenziali.

Simplicity has a new name: One. The collection of bathroom accessories designed by Matteo Thun and Antonio Rodriguez combines linear and clean elements. The vastness of the assortment and formal clarity make One a very flexible solution from the point of view of style and practicality. The One collection is suitable for both commercial and residential environments.







CR
Cromato
Chrome-plated

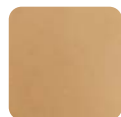

OR
Oro rosato lucido
Glossy rose-coloured gilded



DR
Dorato 24 carati
Gilded 24 carats

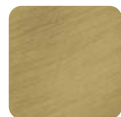

BZ
Bronzo
Bronzed



AC
Nickel spazzolato
Brushed nickel



CG
Cromo nero spazzolato
Brushed black chrome



NE
Nero opaco
Matt black



WM
Bianco opaco
Matt white









A2490
Portasalviette
Towel holder
35 / 50 / 65 / 85 x 5H x 7 cm



A2491C
Portasalviette doppio
Double towel holder
65 x 5H x 12 cm



A2415A
Portasalviette fisso a bandiera
Flag fixed towel holder
5 x 5H x 35 cm



A2415B
Portasalviette doppio a snodo
Double swing arm towel holder
13 x 5H x 37 cm



A2416A
Portasalviette ad anello
Ring towel holder
22 x 23H x 3 cm



A24680
Portateli con portasalviette
Bath towel rack with towel holder
65 x 12H x 30 cm



AV120A
Appendiabiti
Clothes hanger
4 x 4H x 4 cm



click



AV120E
Appendiabiti doppio
Double clothes hanger
15 x 7H x 4 cm



click



AV120B
Appendiabiti doppio
Double clothes hanger
4 x 7H x 4 cm



click



AV120C
Appendiabiti triplo
Triple clothes hanger
25 x 4H x 4 cm



click



AV120D
Appendiabiti quadruplo
Quadruple clothes hanger
42 x 4H x 4 cm



click



A24120
Spandisapone a parete con contenitore in vetro extrachiaro trasparente, erogatore in finitura
Wall-mounted soap dispenser with extra clear transparent glass container and in finish brass pump
8 x 16H x 12 cm



0,25 Lt.



A2410A

Portabicchiere a parete con
bicchiere in vetro extrachiario
trasparente
Wall-mounted tumbler holder
with extra clear transparent
glass tumbler
8 x 11H x 12 cm

**A24110**

Portasapone a parete con
bacinella in vetro extrachiario
trasparente
Wall-mounted soap holder
with extra clear transparent
glass dish
13 x 5H x 14 cm

**A24250**

Portarotolo
Paper holder
17 x 5H x 9 cm

**A2426B**

Portarotolo con coperchio
Paper holder with cover
15 x 11H x 3 cm

**A24260**

Portarotolo con coperchio
Paper holder with cover
14 x 8H x 13 cm

**A2425C**

Portarotolo doppio
Double paper holder
30 x 5H x 9 cm

**A24280**

Portarotolo di scorta
Spare roll holder
5 x 5H x 13 cm

**A13950**

Maniglione di sicurezza
Safety grip
35 x 3H x 7 cm



1,500N
~150Kg

A1390

Maniglione di sicurezza
Safety grip
50 / 65 x 3H x 7 cm



1,200N
~120Kg

AV014

Portascopino da parete/da appoggio.
Scovolo di ricambio incluso
Wall mounted/free-standing toilet brush holder.
Spare brush included
9 x 40H x 9 cm

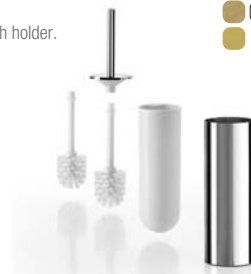

DESIGN BY ALTAKUJOTA

TOUCH

Rounded solid design.

Touch: una gamma pensata per offrire un'ampia scelta sia in fatto di servizio che di tipologia compositiva, una gamma particolarmente articolata per una serie completa di accessori bagno.

Touch: a range designed to offer a large selection choice both in terms of service and composition type, a range particularly articulated to a complete range of bathroom accessories.







CR
Cromato
Chrome-plated





A4618A
Portasalviette
Towel holder
32 x 5H x 8 cm



A4618
Portasalviette
Towel holder
51 / 66 x 5H x 8 cm



A4618
Portasalviette
Towel holder
32 / 51 / 66 / 81 x 5H x 8 cm



A46150
Portasalviette doppio a snodo
Double swing arm towel holder
6 x 9H x 39 cm



A4618U
Portasalviette
Towel holder
60 x 2H x 8 cm



A46160
Portasalviette ad anello
Ring towel holder
22 x 24H x 8 cm



A46200
Appendiabiti
Clothes hanger
5 x 5H x 5 cm



A46210
Appendiabiti doppio
Double clothes hanger
8 x 5H x 6 cm



A46670
Spandisapone a parete con contenitore in vetro satinato, erogatore in ottone cromato
Wall-mounted soap dispenser with satinated glass container and chrome-plated brass pump
8 x 16H x 12 cm



A46100
Portabicchiere a parete con bicchiere in vetro satinato
Wall-mounted tumbler holder with satinated glass tumbler
8 x 11H x 12 cm



A46110
Portasapone a parete con bacinella in vetro satinato
Wall-mounted soap holder with satinated glass dish
13 x 5H x 15 cm



A4611M
Portasapone a parete con bacinella in ottone cromato
Wall-mounted soap holder, with chrome-plated brass dish
11 x 5H x 12 cm



0,25 Lt.

A4667Z

Spandisapone da appoggio con contenitore in vetro satinato, erogatore in ottone cromato
 Tabletop soap dispenser with satined glass container and chrome-plated brass pump
 8 x 19H x 8 cm



0,25 Lt.

A4610Z

Portabicchiere da appoggio con bicchiere in vetro satinato
 Tabletop tumbler, with satined glass tumbler
 8 x 14H x 8 cm

**A4611Z**

Portasapone da appoggio con bacinella in vetro satinato
 Tabletop soap holder with satined glass dish
 13 x 7H x 13 cm

**A4625**

Portarotolo
 Paper holder
 18 x 5H x 8 cm

**A46252**

Portarotolo doppio
 Double paper holder
 38 x 5H x 8 cm

**A4626B**

Portarotolo basculante con coperchio
 Tilting roll holder with cover
 15 x 11H x 5 cm

**A46280**

Portarotolo di scorta
 Spare roll holder
 5 x 18H x 8 cm

**A46510**

Cestino
 Basket
 35 x 6H x 13 cm

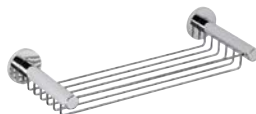
**A46080**

Mensola in cristallo satinato temperato 6 mm con supporti
 Tempered satined crystal shelf, 6 mm glass, with brackets
 60 x 5H x 15 cm

**A4690M**

Maniglione di sicurezza
 Safety grip
 30 x 5H x 6 cm

**AV014**

Portascopino da parete/da appoggio.
 Scovolo di ricambio incluso
 Wall mounted/free-standing toilet brush holder.
 Spare brush included
 9 x 40H x 9 cm







RAFFAELLA

Tradition, timeless past and quality materials.

La serie Raffaella interpreta con eloquenza canoni tradizionali e sapori di un passato senza tempo, che affonda le proprie radici in forme di antica memoria. Le finiture e la qualità dei materiali proposti si rifanno alla tradizione, sottolineando con il loro stile la cura del dettaglio.

The serie Raffaella interprets with eloquence traditional canons and tastes of a timeless past which has its roots in old memory forms. The finishing and the quality of the materials proposed are based on tradition, underlining with their style the attention to the detail.







CR
Cromato
Chrome-plated



DR
Dorato 24 carati
Gilded 24 carats



BZ
Bronzo
Bronzed





A3218
Portasalviette
Towel holder
42 / 57 / 72 x 6H x 9 cm



A32150
Portasalviette doppio a snodo
Double swing arm towel holder
6 x 10H x 48 cm



A32160
Portasalviette ad anello
Ring towel holder
23 x 17H x 9 cm



A32680
Portateli
Bath towel holder
56 x 9H x 25 cm



A32200
Appendiabiti doppio
Double clothes hanger
13 x 7H x 9 cm



A32120
Spandisapone a parete
Wall-mounted soap dispenser
15 x 16H x 12 cm



0,25 Lt.

A32100
Portabicchiere a parete
Wall-mounted tumbler holder
15 x 9H x 12 cm



A32110
Portasapone a parete
Wall-mounted soap holder
17 x 6H x 14 cm



A32250
Portarotolo
Paper holder
20 x 6H x 9 cm



A32260
Portarotolo
Paper holder
18 x 17H x 9 cm



A3226A
Portarotolo con coperchio
Paper holder with cover
18 x 17H x 10 cm



A32500
Cestino
Basket
26 x 6H x 14 cm



A32920
Maniglione con cestino
Grab-bar with basket
42 x 21H x 12 cm



REV

A32080
Mensola in cristallo satinato temperato
5 mm
Tempered satined crystal shelf, 5 mm
glass
72 x 6H x 14 cm



A32850

Piantana con 3 portasalviette
Stand with 3 towel holders
27 x 80H x 56 cm

**A32240**

Piantana con portarotolo e portascopino
Stand with paper and toilet brush holder
16 x 72H x 28 cm

**A37140**

Portascopino da parete/da appoggio
Wall mounted/free-standing toilet brush holder
9 x 45H x 10 cm



DESIGN BY STUDIO INDA

FORUM QUADRA

Curved lines meet square shapes.

Linee curve che si integrano a forme squadrate in un design originale e versatile. Una nuova gamma in cui la funzionalità è protagonista.

Curved lines and square shapes are integrated in a creative and versatile design. A new series where functionality becomes the protagonist.

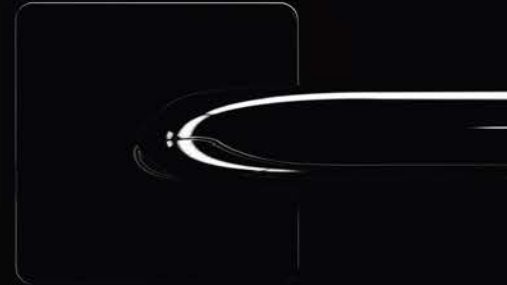



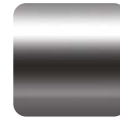

CR
Cromato
Chrome-plated





A3018A
Portasalviette
Towel holder
25 x 5H x 7 cm



A3018
Portasalviette
Towel holder
35 / 50 / 66 / 86 x 5H x 7 cm



A3019C
Portasalviette doppio
Double towel holder
66 x 5H x 13 cm



A3015A
Portasalviette fisso a bandiera
Flag fixed towel holder
7 x 7H x 45 cm



A30150
Portasalviette doppio a snodo
Double swing arm towel holder
8 x 5H x 45 cm



A30160
Portasalviette ad anello
Ring towel holder
18 x 19H x 6 cm



A3020A
Appendiabiti
Clothes hanger
5 x 7H x 7 cm



A3020B
Appendiabiti doppio
Double clothes hanger
7 x 5H x 5 cm



A30120
Spandisapone a parete con contenitore in vetro satinato, erogatore in ottone cromato
Wall-mounted soap dispenser with satined glass container and chrome-plated brass pump
7 x 18H x 13 cm



0,25 LT.

A30100
Portabicchiere a parete con bicchiere in vetro satinato
Wall-mounted tumbler holder with satined glass tumbler
7 x 10H x 12 cm



A3010D
Portabicchiere a parete con 2 bicchieri in vetro satinato
Wall-mounted tumbler holder with 2 satined glass tumblers
19 x 10H x 10 cm



A30110
Portasapone a parete con bacinella in vetro satinato
Wall-mounted soap holder with satined glass dish
11 x 5H x 14 cm



A30250
Portarotolo
Paper holder
18 x 6H x 10 cm

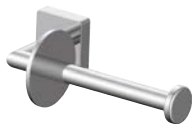

A3025B
Portarotolo basculante
Tilting roll holder
14 x 10H x 6 cm



A30260
Portarotolo basculante con
coperchio
Tilting roll holder with cover
14 x 13H x 7 cm



A30090
Mensola in cristallo satinato temperato
6 mm con supporti
Tempered satined crystal shelf, 6 mm
glass, with brackets
57 x 5H x 14 cm



A30950
Maniglione di sicurezza
Safety grip
32 x 7H x 7 cm



A30140
Portascopino da parete con bacinella in
vetro satinato
Wall-mounted toilet brush holder, with
satined glass dish
11 x 41H x 15 cm

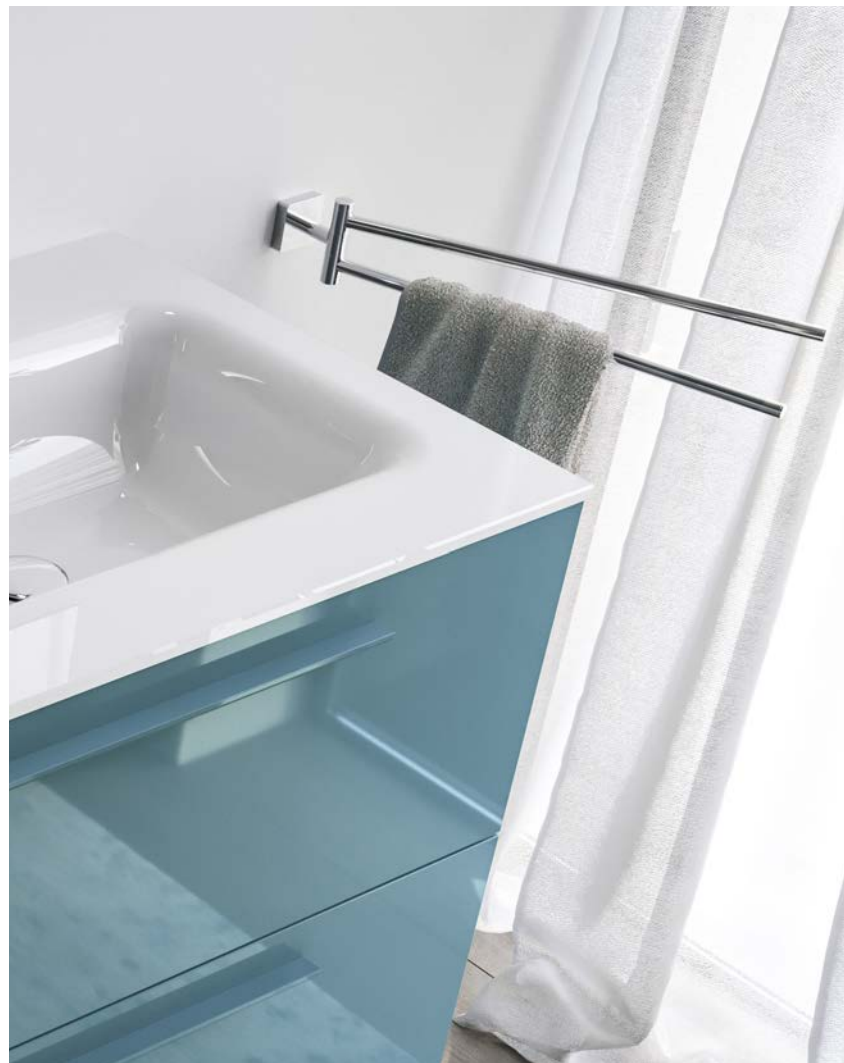

DESIGN BY STUDIO INDA

FORUM

A complete and simple collection.

Forum: una gamma completa con un'estetismo essenziale; una serie pensata per offrire un'ampia scelta di prodotti funzionali.

Forum: a complete range with an essential aestheticism, a series designed in order to offer a large range of functional products.







CR
Cromato
Chrome-plated





R0000K

Kit fissaggio a parete. Include confezione colla (kit opzionale)
Wall mounting kit. Includes glue pack (optional kit)
6 x 6H x 0,5 cm

**A3618A**

Portasalviette
Towel holder
26 x 6H x 7 cm

**A3618**

Portasalviette
Towel holder
36 / 51 / 67 / 87 x 6H x 7 cm

**A3690**

Portasalviette
Towel holder
36 / 51 / 66 x 6H x 8 cm

**A3619C**

Portasalviette doppio
Double towel holder
67 x 6H x 13 cm

**A36150**

Portasalviette doppio a snodo
Double swing arm towel holder
8 x 6H x 46 cm

**A36160**

Portasalviette ad anello
Ring towel holder
18 x 20H x 6 cm

**A3620A**

Appendiabiti
Clothes hanger
6 x 8H x 7 cm

**A3620B**

Appendiabiti doppio
Double clothes hanger
7 x 6H x 5 cm

**A36120**

Spandisapone a parete con contenitore in vetro satinato, erogatore in ottone cromato
Wall-mounted soap dispenser with satinated glass container and chrome-plated brass pump
7 x 18H x 13 cm



0,25 Lt.

A36100

Portabicchiere a parete con bicchieri in vetro satinato
Wall-mounted tumbler holder with satinated glass tumbler
7 x 10H x 12 cm

**A3610D**

Portabicchiere a parete con 2 bicchieri in vetro satinato
Wall-mounted tumbler holder with satinated glass tumblers
19 x 10H x 10 cm

**A36110**

Portasapone a parete con bacinella in vetro satinato
Wall-mounted soap holder with satinated glass dish
11 x 6H x 14 cm



A36250
Portarotolo
Paper holder
19 x 6H x 10 cm



A3625B
Portarotolo basculante
Tilting roll holder
14 x 10H x 6 cm



A36260
Portarotolo basculante con coperchio
Tilting roll holder with cover
14 x 14H x 7 cm



A36920
Maniglione con cestino
Grab-bar with basket
43 x 22H x 12 cm



1.500N
~150Kg



A36950
Maniglione di sicurezza
Safety grip
32 x 7H x 7 cm



1.500N
~150Kg

A36090
Mensola in cristallo satinato temperato
6 mm con supporti
Tempered satinated crystal shelf, 6 mm
glass, with brackets
58 x 6H x 12 cm



A36140
Portascopino da parete con bacinella in
vetro satinato
Wall-mounted toilet brush holder, with
satinated glass dish
11 x 41H x 15 cm



DESIGN BY STUDIO INDA

MY MIRROR

A new light has come.

Una nuova serie di specchi ingranditori, sia d'appoggio che da parete, disponibili anche con luce LED integrata. Sono l'accessorio ideale per il make-up e per vedere i dettagli del proprio viso.

A new serie of magnifying mirrors, both supporting and wall mounted, also available with integrated LED lighting. They are the ideal accessory for makeup and to see the details of your face.







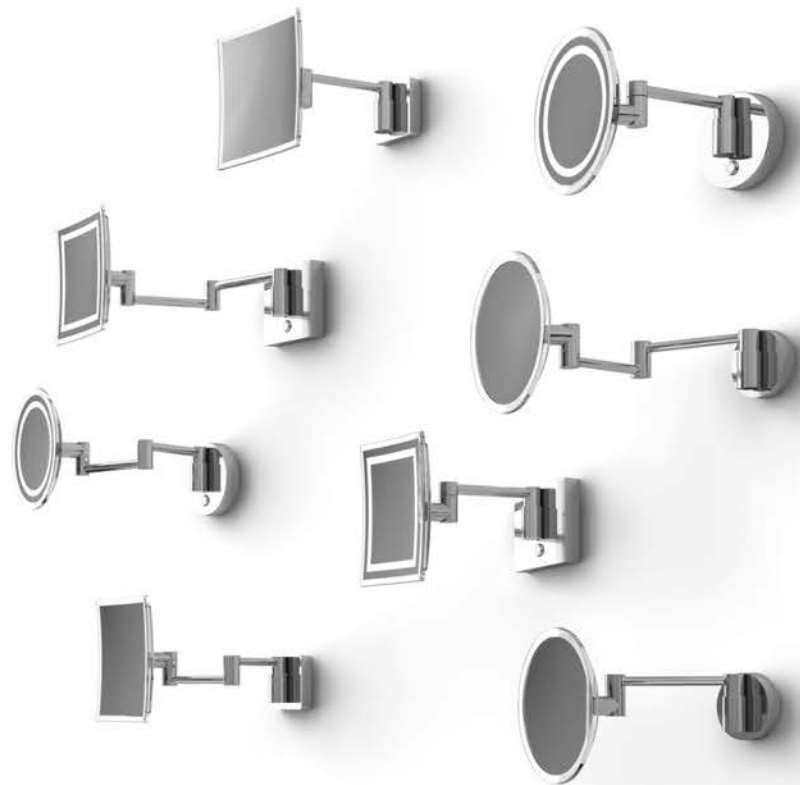

AV258A

Specchio ingranditore a parete con braccio snodato. Accensione touch. Dimmerabilità colore luce. Collegamento diretto a rete o con presa di corrente

Wall-mounted magnifying mirror with articulated arm. Touch switch on. Dimmable light color. Direct connection to the mains or with a socket

20 x 24H x 28 cm
100-240V 50-60Hz 2,5W

**AV258B**

Specchio ingranditore a parete con doppio braccio snodato. Accensione touch. Dimmerabilità colore luce. Collegamento diretto a rete o con presa di corrente

Wall magnifying mirror with double jointed arm. Touch switch on. Dimmable light color. Direct connection to the mains or with a socket

20 x 21H x 43 cm
100-240V 50-60Hz 2,5W

**AV258P**

Specchio ingranditore da appoggio. Accensione touch. Dimmerabilità colore luce

Magnifying mirror with support. Touch switch on. Dimmable light color

20 x 43H x 19 cm
100-240V 50-60Hz 2,5W

**AV258C**

Specchio ingranditore a parete con braccio snodato. Accensione touch. Dimmerabilità colore luce.

Collegamento diretto a rete o con presa di corrente

Wall-mounted magnifying mirror with articulated arm. Touch switch on. Dimmable light color. Direct connection to the mains or with a socket

20 x 24H x 27 cm
100-240V 50-60Hz 2,5W

**AV258D**

Specchio ingranditore a parete con doppio braccio snodato. Accensione touch. Dimmerabilità colore luce. Collegamento diretto a rete o con presa di corrente

Wall magnifying mirror with double jointed arm. Touch switch on. Dimmable light color. Direct connection to the mains or with a socket

20 x 22H x 42 cm
100-240V 50-60Hz 2,5W

**AV258Q**

Specchio ingranditore da appoggio. Accensione touch. Dimmerabilità colore luce

Magnifying mirror with support. Touch switch on. Dimmable light color

20 x 43H x 18 cm
100-240V 50-60Hz 2,5W

**AV058E**

Specchio ingranditore a parete con braccio snodato

Wall-mounted magnifying mirror with articulated arm
20 x 20H x 27 cm

**AV058L**

Specchio ingranditore a parete con doppio braccio snodato

Wall magnifying mirror with double jointed arm
20 x 20H x 42 cm

**AV058P**

Specchio ingranditore da appoggio

Magnifying mirror with support
20 x 41H x 18 cm



AV058F

Specchio ingranditore a parete con braccio snodato
Wall-mounted magnifying mirror with articulated arm
20 x 20H x 27 cm

**AV058M**

Specchio ingranditore a parete con doppio braccio snodato
Wall magnifying mirror with double jointed arm
20 x 20H x 40 cm

**AV058Q**

Specchio ingranditore da appoggio
Magnifying mirror with support
20 x 41H x 17 cm

**AV158C**

Specchio ingranditore a parete con doppio braccio snodato. Collegamento diretto a rete o con presa di corrente
Wall magnifying mirror with double jointed arm. Direct connection to the mains or with a socket
20 x 20H x 43 cm
100-240V 50-60Hz 6W

**AV158O**

Specchio ingranditore a parete con braccio snodato. Collegamento diretto a rete. Tasto on/off
Wall magnifying mirror with jointed arm. Direct connection to the electricity grid. On/off button
22 x 22H x 26 cm
100-240V 50-60Hz 4,5W

**AV058C**

Specchio ingranditore a parete con doppio braccio snodato. Bifacciale. Pivottante
Wall magnifying mirror with double jointed arm. Double sided. Pivoting
23 x 32H x 34 cm

**AV058X**

Specchio ingranditore a parete su asta saliscendi
Wall-mounted magnifying mirror on slide rail bar
20 x 60H x 16 cm

**AV058Y**

Specchio ingranditore a parete su asta saliscendi
Wall-mounted magnifying mirror on slide rail bar
20 x 60H x 15 cm



COMFORT

Functionality, technology and aesthetics come together.

Comfort è una serie progettata da Matteo Thun per rendere l'ambiente bagno raffinato e piacevole, non solo per le persone con mobilità ridotta, ma anche per tutti gli utenti. Funzionalità, tecnologia ed estetica si fondono per servire coloro che hanno bisogno di aiuto e per i quali la sicurezza ha un valore prioritario anche in bagno. La serie è disponibile in due finiture: cromo e cromato/nero soft touch.

Comfort is a serie designed by Matteo Thun in order to make the bathrooms environment pleasing and refined, not only for people with reduced mobility, but (also) for all users. Functionality, technology and aesthetics come together to serve those who need help and for whom safety is a priority in the bathroom. The collection is available in two finishes: chrome and chrome plated/black soft touch.







CR
Cromato
Chrome-plated



CU
Cromato/nero soft touch
Chrome-plated/black soft touch



AH995

Maniglione di sicurezza
Safety grip
44 / 64 x 7H x 9 cm



1.500N
~150Kg

**AH995**

Maniglione di sicurezza
Safety grip
74 / 144 x 7H x 9 cm



1.500N
~150Kg

**AH992A**

Maniglione di sicurezza 135°
Safety grip 135°
55 x 27H x 9 cm



1.500N
~150Kg

**AH993**

Sostegno di sicurezza ad L
L shaped safety support
36 x 67H x 9 cm



1.500N
~150Kg

**AH993**

Sostegno di sicurezza ad L
L shaped safety support
67 x 67H x 9 cm



1.500N
~150Kg

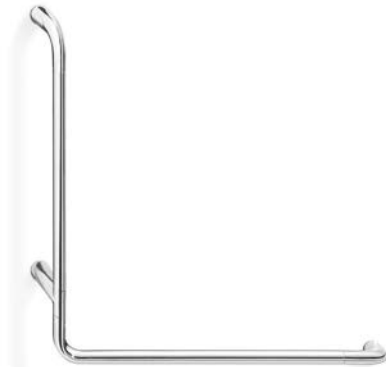

AH996

Sostegno di sicurezza verticale.
Installazione da pavimento a parete
Vertical safety support.
Wall-to-floor installation
7 x 179H x 9 cm



1,500N
~150Kg



1,500N
~150Kg

AH994

Sostegno di sicurezza ad angolo
Corner safety support
76 x 7H x 76 cm

**AH994**

Sostegno di sicurezza ad angolo
Corner safety support
100 x 7H x 66 cm



1,500N
~150Kg

AH9K1A

Supporto a muro con placca design per artt. AH997A - AH997C

Wall support with design plate for arts. AH997A - AH997C
8 x 12H x 1 cm



1.500N
~150Kg

AH997C

Sostegno di sicurezza ribaltabile zona wc
Tip-up safety support. Wc zone
10 x 31H x 70 cm



1.500N
~150Kg

**AH925X**

Portarotolo per artt.
AH997A - AH997C
Paper holder for arts.
AH997A - AH997C
5 x 15H x 16 cm



DESIGN BY STUDIO INDA

GRAB-BARS

Una serie di maniglioni completa e dalle diverse finiture, realizzata secondo alti standard qualitativi per permettere di muoversi nell'ambiente bagno in totale sicurezza e facilità.

A serie of complete handles with different finishes, produced according to high quality standards to allow you to move in the bathroom safely and easily.

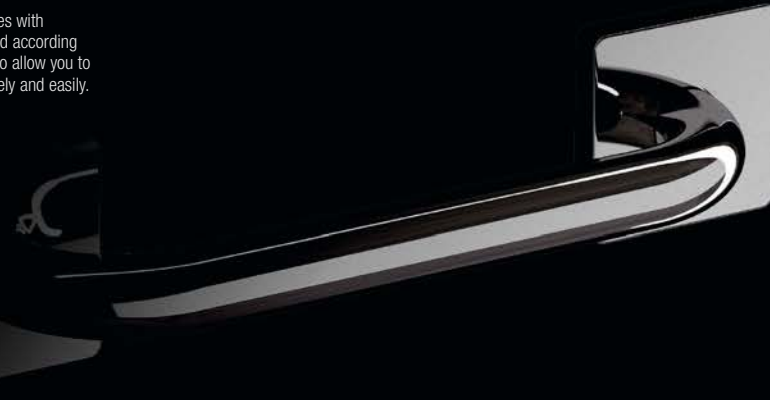



A0490
Maniglione di sicurezza
Safety grip
52 / 67 x 7H x 7 cm



A0490T
Maniglione di sicurezza
Safety grip
32 x 7H x 7 cm



A0491T
Maniglione di sicurezza
Safety grip
43 x 22H x 12 cm



A10950
Maniglione di sicurezza
Safety grip
36 x 5H x 6 cm



A1095
Maniglione di sicurezza
Safety grip
51 / 66 x 5H x 6 cm



A1895
Maniglione di sicurezza
Safety grip
30 / 45 / 60 x 3H x 5 cm



A13950
Maniglione di sicurezza
Safety grip
35 x 3H x 7 cm



A1390
Maniglione di sicurezza
Safety grip
50 / 65 x 3H x 7 cm



A30950
Maniglione di sicurezza
Safety grip
32 x 7H x 7 cm



A36950
Maniglione di sicurezza
Safety grip
32 x 7H x 7 cm



A4690M
Maniglione di sicurezza
Safety grip
31 x 5H x 6 cm



A30920
Maniglione con cestino
Grab-bar with basket
43 x 22H x 12 cm



A36920
Maniglione con cestino
Grab-bar with basket
43 x 22H x 12 cm



A0492T
Maniglione con cestino
Grab-bar with basket
43 x 22H x 12 cm



A32920
Maniglione con cestino
Grab-bar with basket
42 x 21H x 12 cm



A04620
Maniglione per doccia, con
gomma termoplastica antiscivolo
e cestino
Grab-bar for shower, with anti-slip
thermoplastic rubber and basket
34 x 7H x 15 cm



A04610
Appoggiapiedi per doccia con
gomma termoplastica antiscivolo
Foot rest bar for shower with anti-
slip thermoplastic rubber
34 x 3H x 3 cm





DESIGN BY STUDIO INDA

STOOLS

Gli sgabelli doccia sono i complementi d'arredo utili e funzionali perfetti per rendere l'ambiente bagno più comodo e sicuro.

Shower stools are the useful and functional furnishing accessories perfect for making the bathroom environment more comfortable and safer.



AV036B

Sedile ribaltabile per doccia.
Antibatterico
Folding shower seat. Antibacterial
35 x 18H x 38 cm



1.600N
~160Kg

A0436A

Sedile ribaltabile per doccia
Folding shower seat
35 x 5H x 35 cm



1.600N
~160Kg

**AV375B**

Sgabello con seduta in ABS e struttura
in ottone cromato. Antibatterico
Stool with seat, brass structure.
Antibacterial
35 x 46H x 33 cm



DESIGN BY STUDIO INDA

BASKETS

Design e funzionalità si fondono per questa rinnovata serie di cestini per doccia: angolari, removibili, con vaschetta interna o appendibili alla parete doccia, offrono una scelta ampia e variegata.

Design and functionality come together for this renewed serie of shower baskets: angular, removable, with internal tray or suspended from the shower wall, they offer a wide and varied choice.

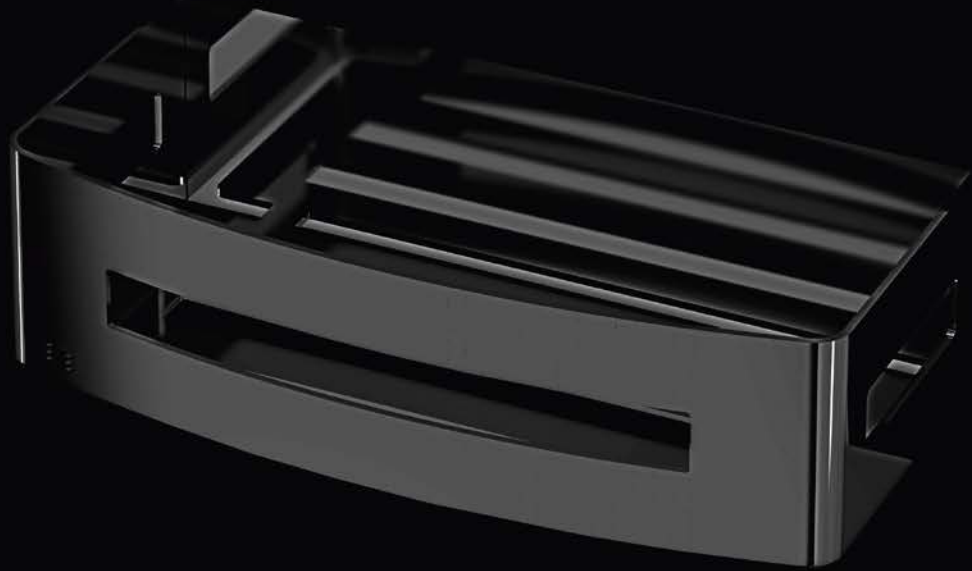





156_BASKETS



AV251A

Cestino con bacinella antibatterica estraibile. Bacinella antiscivolo e anti-UV
 Basket with removable antibacterial basin. Anti-slip and anti-UV basin
 22 x 7H x 11 cm

**AV251C**

Cestino in ABS
 ABS basket
 23 x 9H x 11 cm



click

AV151E

Cestino sganciabile
 Removable basket
 26 x 7H x 12 cm

**AV151F**

Cestino sganciabile
 Removable basket
 22 x 6H x 12 cm

**AV151D**

Cestino sganciabile
 Removable basket
 26 x 3H x 12 cm



A1849A
Cestino
Basket
15 x 3H x 10 cm



A1851A
Cestino
Basket
25 x 3H x 12 cm



A18510
Cestino
Basket
20 x 7H x 13 cm



A46510
Cestino
Basket
35 x 6H x 13 cm

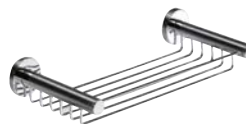

A32500
Cestino
Basket
21 x 6H x 14 cm



A1351A
Cestino
Basket
27 x 4H x 11 cm



A1051B
Cestino
Basket
29 x 3H x 13 cm



A0451H
Cestino
Basket
20 x 6H x 13 cm



A04500
Cestino
Basket
13 x 3H x 9 cm



A04510
Cestino
Basket
20 x 3H x 12 cm



A0453H
Cestino
Basket
39 x 6H x 13 cm

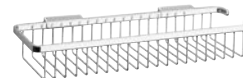

AV0330
Cestino doppio appendibile
Double basket, for hanging
26 x 75H x 25 cm



AV231A

Angolare con bacinella antibatterica estraibile. Bacinella antiscivolo e anti-UV
 Angular with removable antibacterial cup. Anti-slip and anti-UV cup
 18 x 7H x 18 cm

**AV231C**

Angolare in ABS
 ABS corner
 18 x 8H x 18 cm

**AV131F**

Angolare sganciabile
 Removable corner
 17 x 6H x 17 cm

**AV131E**

Angolare sganciabile
 Removable corner
 19 x 7H x 19 cm

**AV131D**

Angolare sganciabile
 Removable corner
 19 x 3H x 19 cm



A18310
Angolare
Corner
16 x 7H x 17 cm



A1331A
Angolare
Corner
18 x 4H x 18 cm



A1031B
Angolare
Corner
21 x 2H x 21 cm



AV031A
Angolare
Corner
22 x 9H x 22 cm



A0449H
Angolare
Corner
16 x 6H x 16 cm



A04490
Angolare
Corner
16 x 3H x 16 cm



AV032A
Angolare doppio
Double corner
22 x 39H x 21 cm



AV0320
Angolare doppio
Double corner
20 x 38H x 21 cm



A04320
Angolare con 2 ripiani in PMMA
Double corner shelf in PMMA
17 x 32H x 17 cm



AV033A
Angolare doppio appendibile a destra
Double corner, right mounting
20 x 75H x 32 cm



AV033B
Angolare doppio appendibile a sinistra
Double corner, left mounting
20 x 75H x 32 cm



STANDS

Nel valore della semplicità, le piantane nascono da una interpretazione del classico fra eleganza nelle forme e essenzialità nei materiali. Accessori dove funzionalità ed estetica si fondono in un raro equilibrio esaltato dalla cura per il dettaglio.

In the simplicity value, the stands born from an interpretation of classic between elegance in the forms and the essentiality of materials. Accessories where functionality and aesthetics are blended together in a rare equilibrium, enhanced by the care for details.

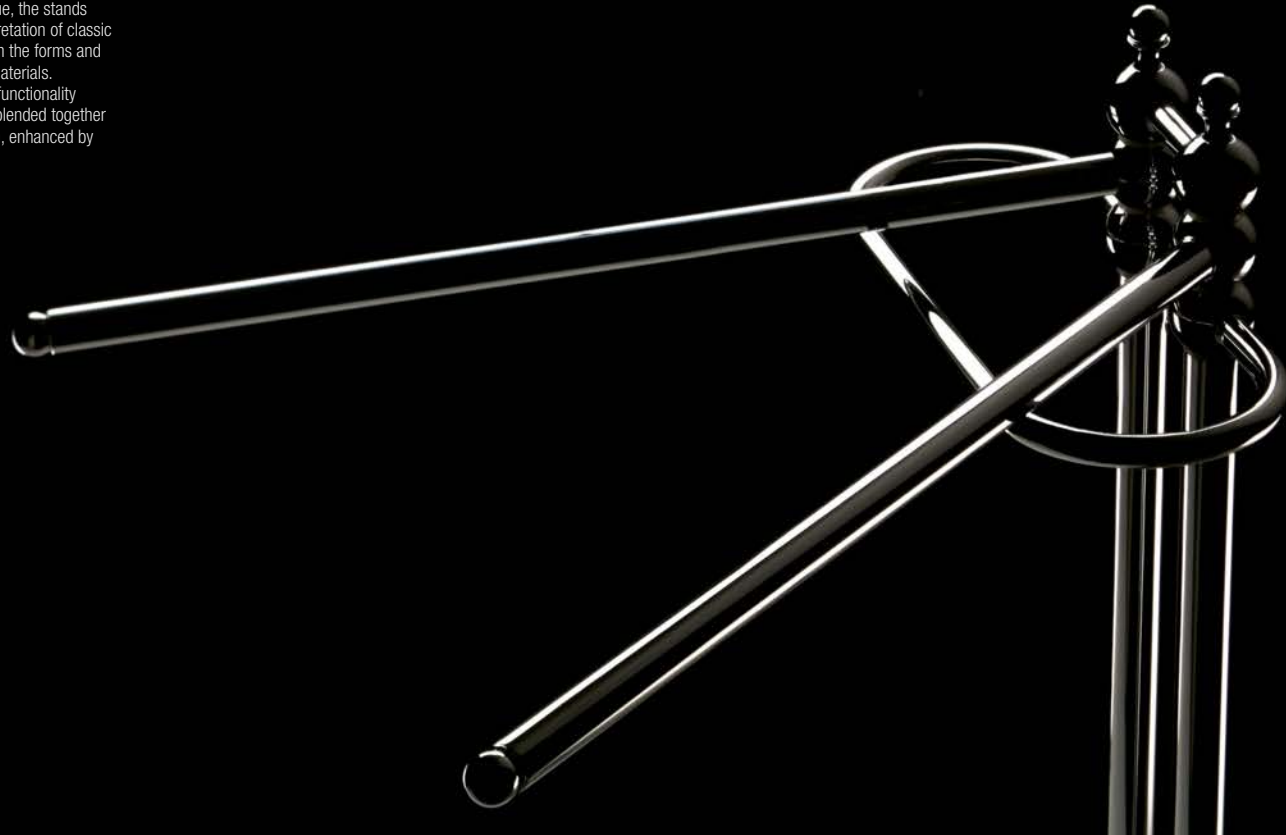



A33850

Piantana con 2 portasalviette
Stand with 2 towel holders
24 x 88H x 40 cm

**AV085C**

Piantana con 2 portasalviette
Stand with 2 towel holders
46 x 90H x 25 cm

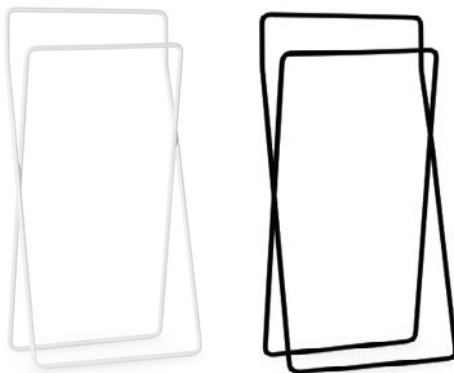
**A05840**

Piantana con 3 portasalviette
Stand with 3 towel holders
27 x 89H x 55 cm

**A05850**

Piantana con 4 portasalviette
Stand with 4 towel holders
27 x 96H x 55 cm

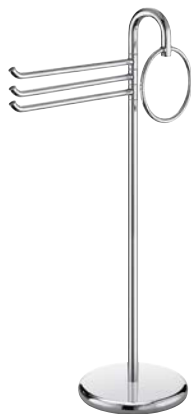
**AV085D**

Piantana con 3 portasalviette
Stand with 3 towel holders
26 x 89H x 48 cm

**AV085F**

Piantana con 3 portasalviette
Stand with 3 towel holders
19 x 88H x 39 cm



AV086D

Piantana con portarotolo e portascopino
Stand with paper and toilet brush holder
26 x 73H x 26 cm

**AV086E**

Piantana con portarotolo e portascopino
Stand with paper and toilet brush holder
19 x 72H x 30 cm

**A32850**

Piantana con 3 portasalviette
Stand with 3 towel holders
27 x 80H x 42 cm

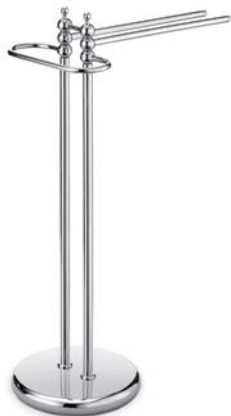
**A23240**

Piantana con portarotolo e portascopino
Stand with paper and toilet brush holder
16 x 72H x 28 cm



DESIGN BY STUDIO INDA

TABLETOP SERIES

Accessori dal design contemporaneo, essenziale e dalle forme semplici e facili da pulire, curati nei dettagli e abbinabili perfettamente a tutte le Serie Inda.

Accessories with a contemporary design, essential and simple shapes that are easy to clean, with attention to detail and perfectly suited to all Inda series.





A2012Z

Spandisapone da appoggio, con contenitore in vetro extrachiaro trasparente o satinato ed erogatore in finitura
 Tabletop soap dispenser with extra clear transparent or satined glass container and pump in finishing
 9 x 16H x 9 cm



0,25 Lt.

**A2010Z**

Portabicchiere da appoggio con bicchiere in vetro extrachiaro trasparente o satinato
 Tabletop tumbler holder with extra clear transparent or satined glass tumbler
 9 x 11H x 9 cm

**A2011Z**

Portasapone da appoggio con bacinella in vetro extrachiaro trasparente o satinato
 Tabletop soap holder with extra clear transparent or satined glass dish
 11 x 4H x 11 cm

**A1812Z**

Spandisapone da appoggio, con contenitore in vetro satinato ed erogatore in finitura
 Tabletop soap dispenser with satined glass container and pump in finishing
 7 x 15H x 7 cm



0,25 Lt.

**A1810Z**

Portabicchiere da appoggio con bicchiere in vetro satinato
 Tabletop tumbler holder with satined glass tumbler
 7 x 10H x 7 cm

**A1811Z**

Portasapone da appoggio con bacinella in vetro satinato
 Tabletop soap holder with satined glass dish
 12 x 4H x 12 cm

**A20060**

Spandisapone da appoggio, con contenitore in vetro satinato ed erogatore in finitura
 Tabletop soap dispenser with satined glass container and pump in finishing
 8 x 16H x 8 cm



0,35 Lt.

**A20010**

Portabicchiere da appoggio con bicchiere in vetro satinato
 Tabletop tumbler holder with satined glass tumbler
 8 x 10H x 8 cm

**A20020**

Portasapone da appoggio con bacinella in vetro satinato
 Tabletop soap holder with satined glass tumbler
 13 x 5H x 13 cm



A4667Z

Spandisapone da appoggio con contenitore in vetro satinato, erogatore in ottone cromato
 Tabletop soap dispenser with sae container and chrome-plated br.
 8 x 19H x 8 cm



0,25 Lt.

AV1060

Spandisapone da appoggio
 Tabletop soap dispenser
 6 x 21H x 8 cm

**AV0710**

Portakleenex da appoggio in ABS
 Tabletop kleenex dispenser in ABS
 26 x 6H x 14 cm

**AV071Z**

Portakleenex da appoggio in ABS
 Tabletop kleenex dispenser in ABS
 14 x 13H x 15 cm

**A4610Z**

Portabicchiere da appoggio con bicchiere in vetro satinato
 Tabletop tumbler, with satined glass tumbler
 8 x 14H x 8 cm

**AV1010**

Bicchiere da appoggio
 Tabletop tumbler
 7 x 11H x 7 cm

**A4611Z**

Portasapone da appoggio con bacinella in vetro satinato
 Tabletop soap holder with satined glass dish
 13 x 7H x 13 cm



FINISHES

La creatività trova libera espressione in un sistema sartoriale dei nostri spazi, dei nostri gusti e della nostra identità. Ampia gamma di finiture per la personalizzazione di un ambiente esclusivo.

Creativity finds its expression in a system always tailored to one's spaces, tastes and identity.
Wide range of finishes for customizing an exclusive environment.



Freedom of being

Inda propone un'unica soluzione cromatica per tutta la stanza da bagno, con 15 colori opachi selezionati per:

- le pareti doccia WALK IN e CLAIRE DESIGN

- gli accessori LEA, GEALUNA, MY LOVE e MY SECRET

- lo specchio PIRANO

da abbinare alle stesse finiture mobili e piani top, ai lavabi integrati Giotto e ai lavabi in appoggio in mineralguss.

Inda suggests an entire colour solution for your bathroom, with 15 selected matt shades for:

- WALK IN and CLAIRE DESIGN shower enclosures

- LEA, GEALUNA, MY LOVE and MY SECRET accessories

- PIRANO mirror

to be combined with the same finishes of cabinets and worktops, Giotto integrated washbasins and tabletop washbasins in mineral marble.



GF
Laccato opaco Grafite
Mat lacquered Grafite



TN
Laccato opaco Titanio
Mat lacquered Titanio



BD
Laccato opaco Blu denim
Mat lacquered Blu denim



AV
Laccato opaco Avio
Mat lacquered Avio



PT
Laccato opaco Platino
Mat lacquered Platino



CX
Laccato opaco Creta
Mat lacquered Creta



ST
Laccato opaco Seta
Mat lacquered Seta



MP
Laccato opaco Perla
Mat lacquered Perla

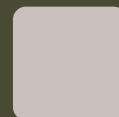

AX
Laccato opaco Avorio
Mat lacquered Avorio



VV
Laccato opaco Verde salvia
Mat lacquered Verde salvia



VF
Laccato opaco Verde felce
Mat lacquered Verde felce

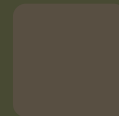

BN
Laccato opaco Bruno
Mat lacquered Bruno



VN
Laccato opaco Avana
Mat lacquered Avana



VS
Laccato opaco Visone
Mat lacquered Visone



TL
Laccato opaco Terra di Luna
Mat lacquered Terra di Luna



CR
Cromato
Chrome-plated



AL
Acciaio Inox AISI 304
Stainless steel AISI 304



AP
Alluminio lucido
Polished aluminium



SL
Silver
Silver



AC
Nickel spazzolato
Brushed nickel



CG
Cromo nero spazzolato
Brushed black chrome



AS
Acciaio inox satinato AISI 304
Satin stainless steel AISI 304

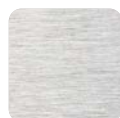

NS
Acciaio inox spazzolato AISI 304
Brushed stainless steel AISI 304



OR
Oro rosato lucido
Glossy rose-coloured gilded



DR
Dorato 24 carati
Gilded 24 carats

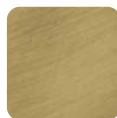

BZ
Bronzo
Bronzed



WM
Bianco opaco
Matt white



WZ / WW
Bianco lucido 9016
Glossy white 9016



WY
Bianco opaco/cromato
Matt white/chrome-plated



NE
Nero opaco
Matt black



NW
Nero
Black



SN
Silver/nero
Silver/black



CU
Nero opaco/cromato
Matt black/chrome-plated



NC
Nero opaco/cromato
Matt black/chrome-plated



CO
Carbonio



RM
Rame



CS
Classic

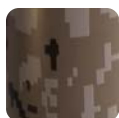

ML
Militare

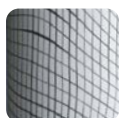

GE
Geometric



Textil ice

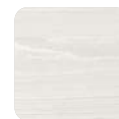

Larice panna

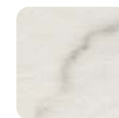

Calacatta

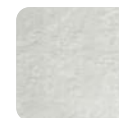

Malta



Textil grey



Larice sand

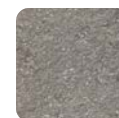

Porfido



Pietra chiara



Textil brown



Larice brown



Pietra scura



Cemento scuro



Fiore bianco



Fiore nero



Yard



Lava

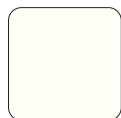

BX
Laccato opaco Bianco
Mat lacquered Bianco



CE
Laccato opaco Cemento
Mat lacquered Cemento



NX
Laccato opaco Nero
Mat lacquered Nero



TL
Laccato opaco Terra di Luna
Mat lacquered Terra di Luna



AQ
Laccato opaco Aquamarina
Mat lacquered Aquamarina



MP
Laccato opaco Perla
Mat lacquered Perla



CX
Laccato opaco Creta
Mat lacquered Creta



AX
Laccato opaco Avorio
Mat lacquered Avorio



BN
Laccato opaco Bruno
Mat lacquered Bruno



GD
Laccato opaco Giada
Mat lacquered Giada



01
Vetro trasparente
Transparent glass



03
Vetro extrachiaro trasparente
Extra clear transparent glass



02
Polimetilmetacrilato
Polymethyl methacrylate



21 / 26
Vetro satinato
Satined glass



07
Ceramica bianca
White ceramic

	CR Cromato Chrome-plated	AC Nickel spazzolato Brushed nickel	CG Cromo nero spazzolato Brushed black chrome	OR Oro rosato lucido Glossy rose-coloured gilded	DR Dorato 24 carati Gilded 24 carats	BZ Bronzo Bronzed	AL Acciaio inox AISI 304 Stainless steel AISI 304	NE Nero opaco Matt black	WM Bianco opaco Matt white	NS Acciaio inox spazzolato AISI 304 Brushed stainless steel AISI 304	AS Acciaio inox satinato AISI 304 Satin stainless steel AISI 304	CU Cromato/nero soft touch Chrome-plated/black soft touch	YOUR OWN COLOR
MY ART *	•							•	•				
MY LOVE	•	•	•	•	•	•		•	•		•		•
MY WAY	•							•	•		•		
MY LIKE							•	•		•			
MY SECRET													•
CLAIRE	•	•						•					
INDISSIMA								•	•	•			
INDISSIMA CHROME	•												
GEALUNA	•									•			•
MITO	•	•						•	•				
DIVO	•							•					
LEA	•	•	•	•	•	•		•	•				•
ONE	•	•	•	•	•	•		•	•				
TOUCH	•												
RAFFAELLA	•				•	•							
FORUM QUADRA	•												
FORUM	•												
COMFORT	•											•	

01 - 03 Vetro trasparente Transparent glass													
21 - 26 Vetro satinato Satined glass											•		
04 Vetro Fumé Fumé glass											•		
07 Ceramica bianca White ceramic													•

* collection 22; page 12

SYMBOL KEY



Marchio TÜV - Certifica la resistenza meccanica sotto i carichi indicati.
TUV mark - It certifies the mechanical resistance to the indicated loads.



Marchio CE
CE mark



Bacinella con foro
Dish with hole



Fissaggio con tasselli
Fixing with plugs



Antibatterico
Antibacterial



Illuminazione a led
Led lighting

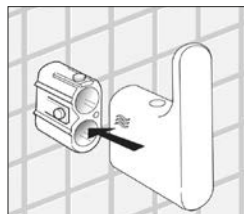

Sistema autocentrante
Self-centering-system



Regolazione del colore della luce
Light color adjustment



Ricaricabile
Rechargeable



Regolazione dell'intensità della luce
Light intensity adjustment

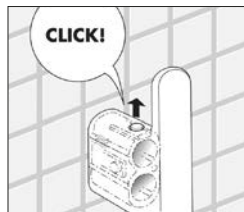

Capacità di contenimento
Containment capacity



Temperatura del colore della luce (tonalità)
Color temperature



Resistenza meccanica
Mechanical resistance



Grado di protezione IP
IP protection level



Possibile installazione a muro mediante adesivo in pasta
Possible wall-mounted installation with paste adhesive



Installazione reversibile
Reversible installation



Fattore di ingrandimento
Magnifying factor



Kit fissaggio a parete
Fixing kit with glue



Installazione non reversibile
Not reversible installation



Presca elettrica
Electrical plug



4 ore di posa
4 hours of laying



Articoli sganciabili
Removable products



No presa elettrica
No electrical socket

Inda si riserva, a proprio insindacabile giudizio, di apportare modifiche anche senza preavviso, allo scopo di migliorare la produzione.

Inda reserves the right to modify the products without advance notice to improve production.

INDA SpA

Registered Office
Operational Headquarters
Via dell'Industria, 41
I-24040 Pagazzano (BG)

Bathroom Furniture
Via Postumia Ovest, 72
I-31048 Olmi di San Biagio di Callalta (TV)

www.inda.net
info@inda.net

PIva: IT03868760962
Registro Imprese di Bergamo: 03868760962
Numero REA: BG – 386581
Capitale Sociale: Euro 4.000.000,00 i.v.



